



# ADDERView® CCS-MV4224

User Guide



## Introduction

Welcome .....	2
Technical specifications .....	3
Supplied items .....	4
Optional extras.....	5

## Installation

Connections .....	6
Computer connections.....	7
Console connections.....	8
Remote control connection .....	9
Power connection.....	9

## Configuration

Initial display setup .....	10
General configuration .....	10
Using with dual head computers .....	10
Using the OSD.....	11
Channel names.....	11
Changing channel indicator colors .....	11
Video Settings .....	12
Channel Settings .....	13
USB Settings .....	14
Audio Settings .....	15
Advanced Settings .....	16
System Information.....	17
Copy & Paste.....	18
Installing the Copy & Paste driver .....	18
Enabling the COM Device mode.....	18
Enabling the USB Device mode.....	19
CCS-MV upgrade process.....	20

## Operation

Displaying windows.....	21
Switching between channels .....	22
Managing windows .....	22
Entering and exiting system mode .....	22
Taking control of a window .....	22
Custom Preset Layouts.....	23
Resizing and moving windows .....	23
Using Copy & Paste .....	24
Using the COM Device mode.....	24
Using the USB Device Mode .....	24

## Further information

Getting assistance .....	25
Appendix A - Hotkey commands .....	26
Appendix B – Open Source Licenses .....	27

## Index

# Introduction



## WELCOME

Thank you for choosing the ADDERView™ CCS-MV4224 multi-viewer switch for working simultaneously with up to four computers. You can choose to view the output of any computer on either connected video display or view all four outputs on one display. Focus automatically changes between computers as the mouse pointer is moved into each related window.

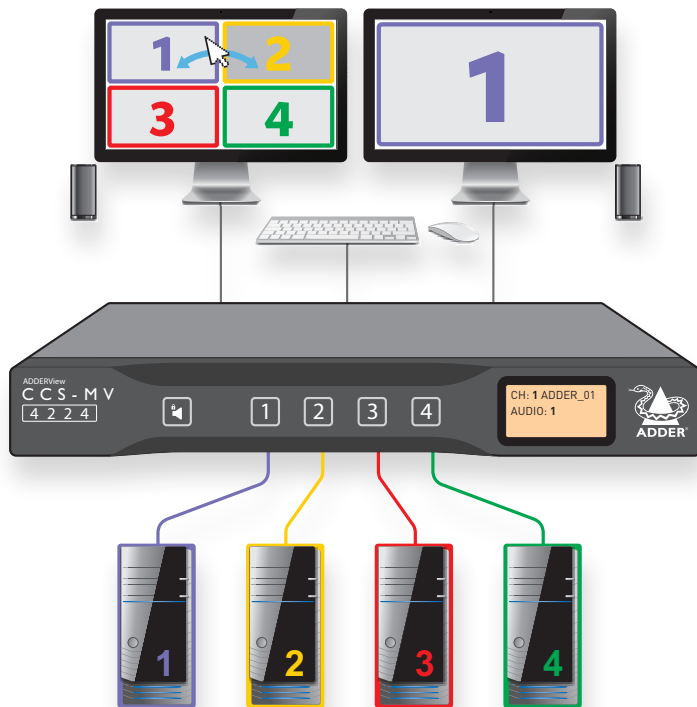

Switching between computers can also be controlled from the smart front panel or by using keyboard shortcuts or remote control API.

## Features

- Automatic switching between ports without the need to press any buttons. Simply move the mouse between windows.
- High quality 4K video resolution.
- Dual video outputs where the second output either duplicates the first or extends the desktop.
- Connects to either single or dual head computers.
- Analog audio with Hold feature.
- Digital audio with mixer function that combines output from multiple channel inputs.
- SuperSpeed USB 3.0 ports for isochronous and mass media devices.
- Clear channel identification to reduce the chances of operator error by displaying a user defined name for each channel on the status display. The color of the channel indicators may also be configured.

## Safety

Please refer to the safety booklet provided in the box before use of this product.

INSTALLATION

CONFIGURATION

OPERATION

FURTHER INFORMATION

INDEX

## TECHNICAL SPECIFICATIONS

### Approvals / Compliance

CE, UKCA, FCC class A, TUV US & Canada

### Video resolutions

Inputs: Up to 3840 x 2160 @ 30 Hz.

Outputs: Up to 2560 x 1600 @ 60 Hz or 3840 x 2160 @ 30 Hz.

### Software compatibility

Windows, Linux, Mac host computer OS's USB HID, including touchscreens compliant with Microsoft® Digitizer.

### Computer connections

4x Dual ports for DisplayPort™ or HDMI®

4x USB 2.0 Full Speed type B

4x USB 3.0 SuperSpeed type B

4x Audio (3.5mm)

### Console connections

2x Digital port for HDMI

2x USB 2.0 Full Speed type A

4x USB 3.0 SuperSpeed type A

Audio (3.5mm)

RJ12 serial port

### Front panel

Audio hold button and status LED

4x Channel selection button and status LED

E-paper for status display (212 x 104)

### Physical design

Robust metal construction

13.54"/344mm(w), 1.73"/44mm(h), 6.34"/161mm(d) 1.6kg/3.53lbs

### Power supply

100 - 240V AC, 47/63Hz

12VDC 30W output from power supply unit

### Environmental

Operating temp: 32°F to 104°F (0°C to 40°C)

Storage temp: -4°F to 140°F (-20°C to 60°C)

Humidity: 0-80% RH, non-condensing

MTBF: 84K hours at 40°C using Telcordia SR-332 Issue 3

# SUPPLIED ITEMS

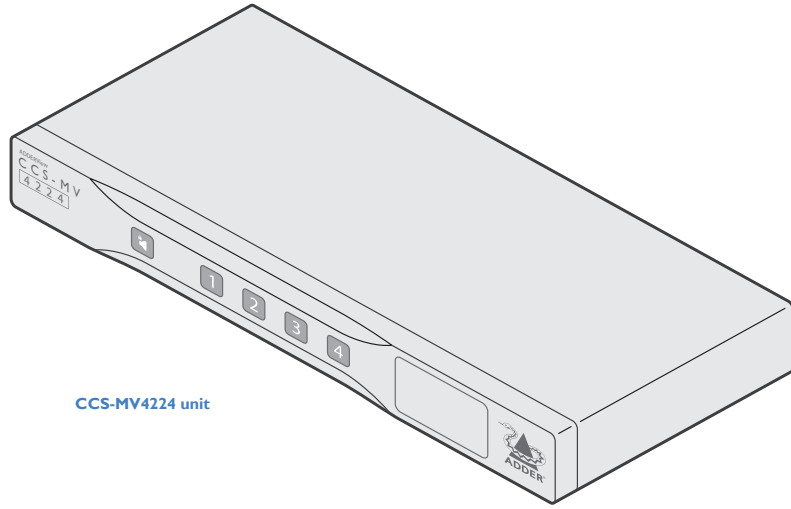

CCS-MV4224 unit

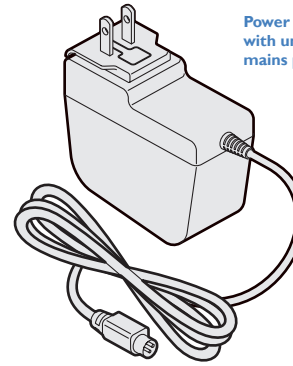

Power adapter with universal mains plug

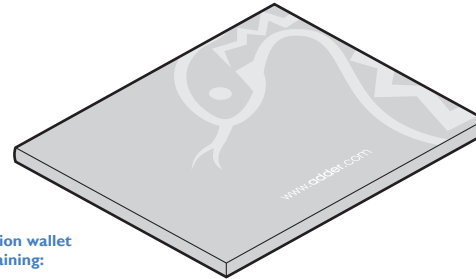

**Information wallet containing:**  
Four self-adhesive rubber feet  
Quick start guide  
Safety document

# OPTIONAL EXTRAS

**19" rack-mount kit**  
Part number: RMK13

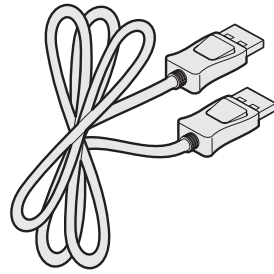
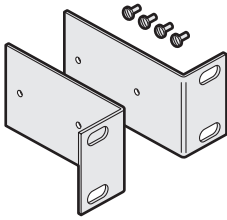

**DisplayPort to DisplayPort video cable**  
Part number: VSCD18

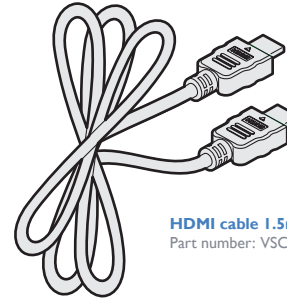

**HDMI cable 1.5m**  
Part number: VSCD15

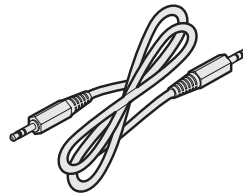

**Audio cable 2m  
(3.5mm stereo jacks)**  
Part number: VSC22

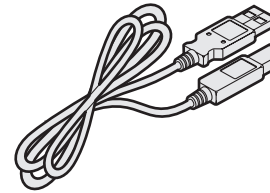

**USB cable 2m (type A to B)**  
Part number: VSC24

# Installation

## CONNECTIONS

All connections are made at the rear panel.  
Use only approved shielded cables, particularly for the video connections. Ensure that all connections are made before applying power.

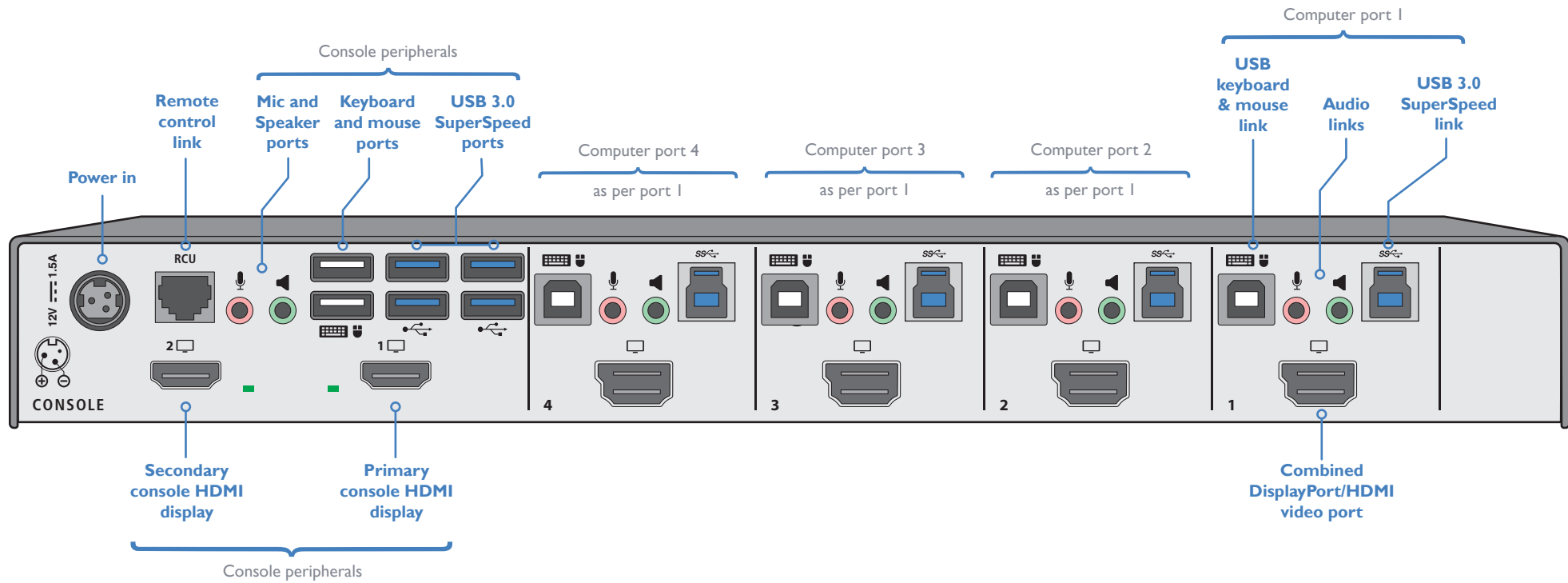

## Computer connections

The multi-viewer switch has four computer ports, each of which consists of: dual DisplayPort/HDMI video links, two USB links and two audio connections. The unit supports video input resolutions up to 3840 x 2160 @ 30Hz.

### To make connections (to each computer port)

1 Attach either a DisplayPort or HDMI cable between the combined video input port and the primary video output connector on the computer.

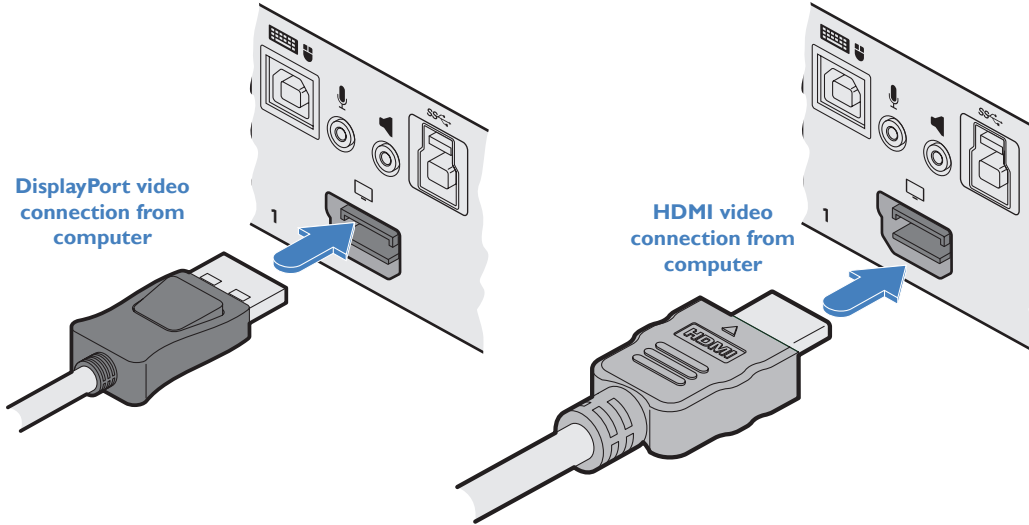

2 Each computer port has two USB sockets a Full Speed (v2.0) one which serves the console keyboard and mouse and also a SuperSpeed (v3.0) blue socket which feeds to the four blue SuperSpeed type A console sockets - useful when using high speed and/ or isochronous devices. Insert suitable link cables between these ports USB and vacant USB ports of the same type on the computer.

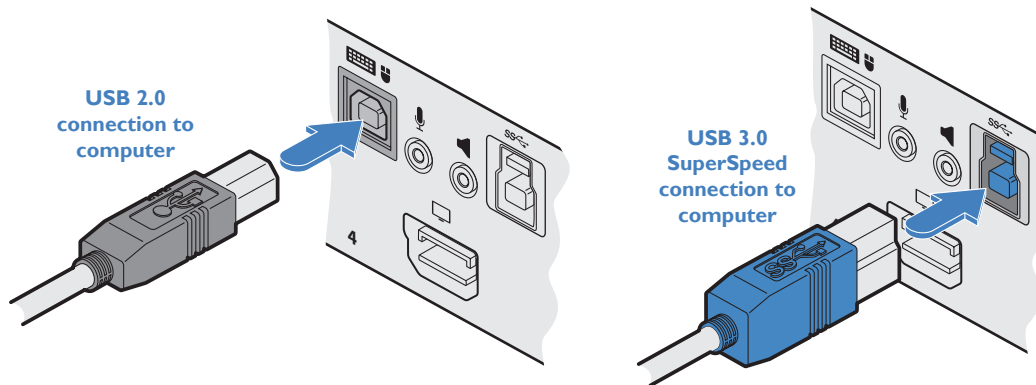

3 Use 3.5mm audio cables to link the mic and speaker jacks to the equivalent ports on the computer.

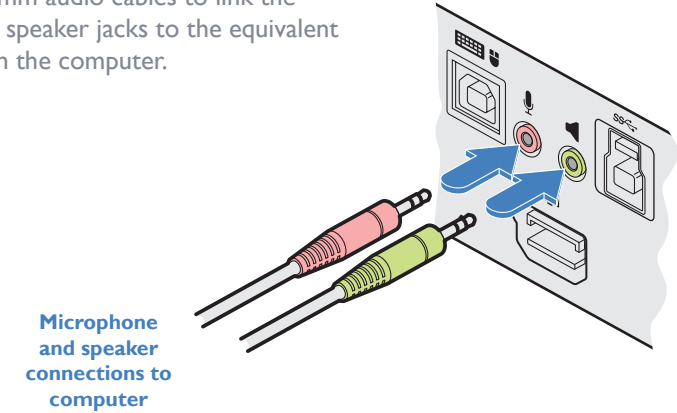



## Console connections

The video display(s), keyboard, mouse and speakers are attached to the various connectors on the rear panel that constitute the console port. The unit supports video display resolutions up to 3840 x 2160.

### To make console connections

- 1 Attach the primary video display to the HDMI connector marked '1'.
- 2 Where a secondary video display is also to be used, repeat step 1 for the HDMI connector marked '2'.

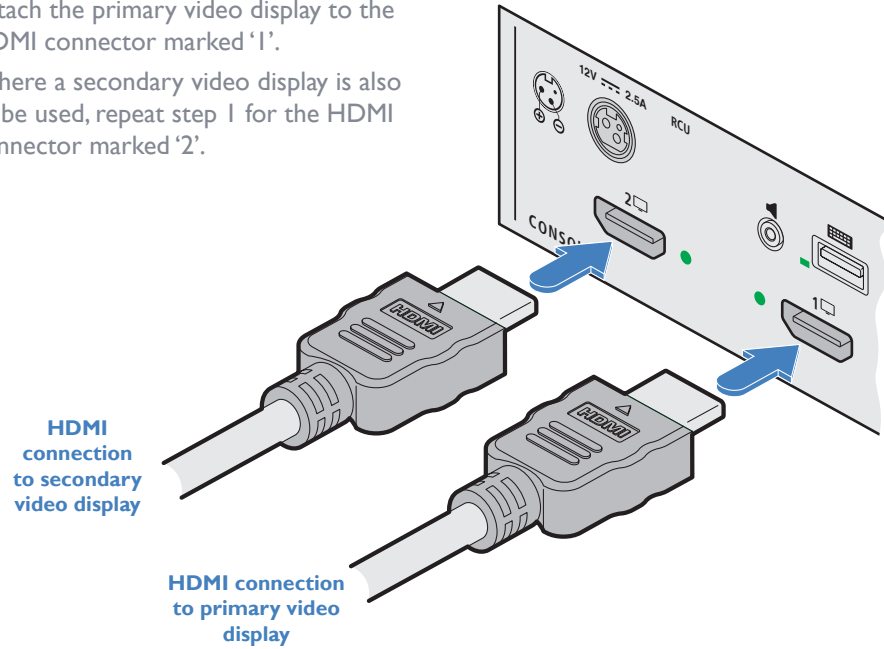

- 3 Connect the console microphone and speakers into the 3.5mm audio output sockets on the rear panel.

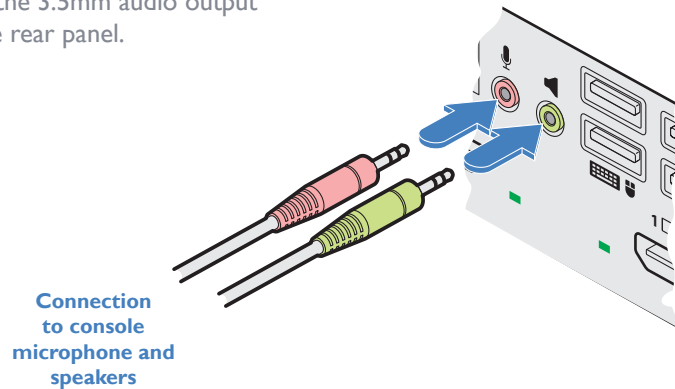

- 4 There are six USB ports within the Console section: Two Full Speed (v2.0) type A sockets for the keyboard and mouse as well as four SuperSpeed (v3.0) type A blue sockets - useful when using high speed and/or isochronous devices. Connect the required devices to the USB sockets on the rear panel.

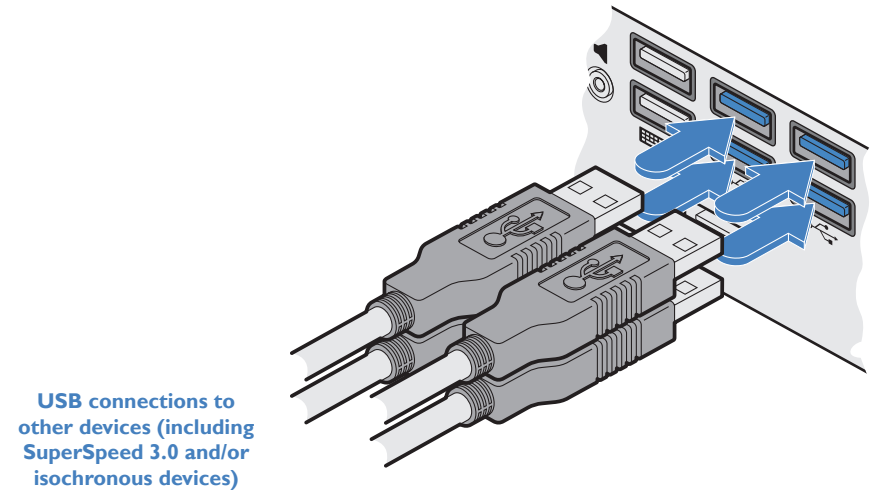
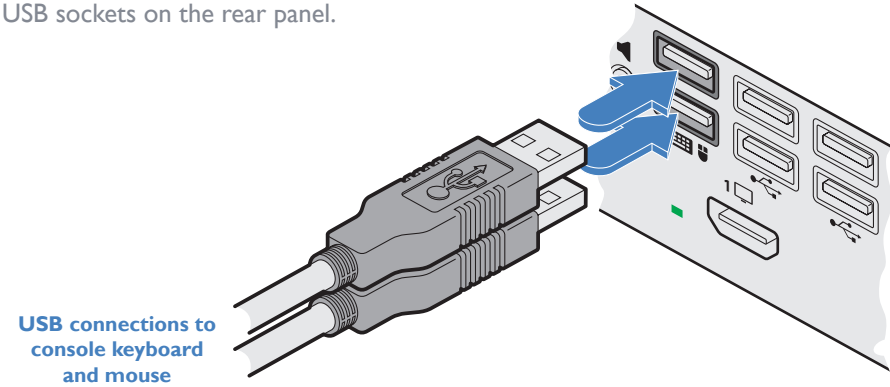

## Remote control connection

The RCU port allows the switch unit to be connected to, and controlled by an external source. Refer to the API Manual (MAN-0000023) for further details.

### To connect a remote control source

- 1 Insert the plug from a remote control source cable into the RCU socket on left side of the rear panel.

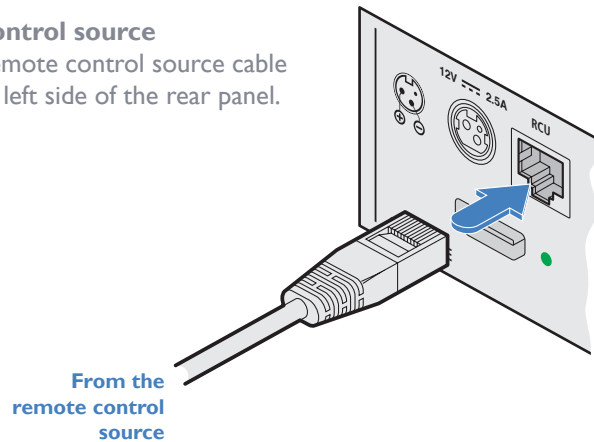

Note: When the switch is under remote control, the front panel indicators will continue to reflect the current selected channel, however, the buttons will have no effect.

## Power connection

**IMPORTANT:** Ensure that the video displays connected to the multi-viewer switch are powered on before applying power to the multi-viewer switch itself.

The supplied power adapter uses a locking-type plug to help prevent accidental disconnection from the multi-viewer switch; please follow the instructions below when disconnecting the power adapter.

### To connect the power adapter

- 1 Attach the output plug of the supplied power adapter to the power input socket on the left side of the rear panel. As you insert the plug, pull back slightly on the outer body to assist the locking mechanism until the plug is fully inserted.

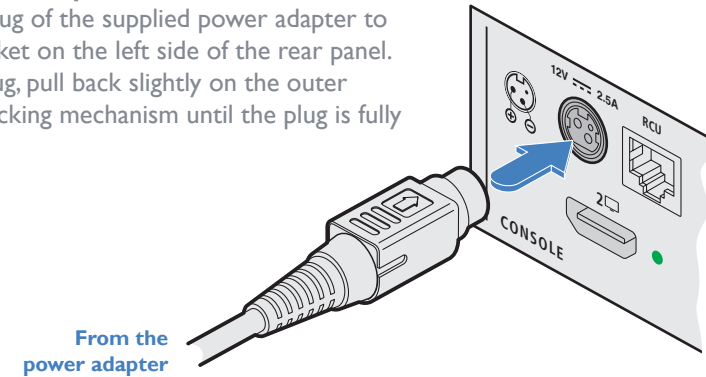

- 2 Attach the appropriate country-specific plug to the power adapter body and insert it into a nearby mains outlet.

### To disconnect the power adapter

- 1 Isolate the power adapter from the mains supply.
- 2 Grasp the outer body of the power adapter plug where it connects with the node.
- 3 Gently pull the body of the outer plug away from the node. As the body of the plug slides back, it will release from the socket and you can fully withdraw the whole plug.

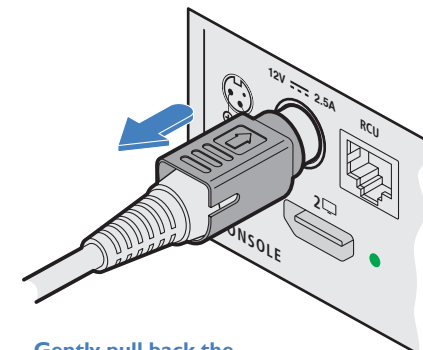

**IMPORTANT:** Please read and adhere to the electrical safety information given within the supplied safety guide. In particular, do not use an unearthed power socket or extension cable.

## INITIAL DISPLAY SETUP

The multi-viewer switch defaults to an output resolution of 3840 x 2160. If you are using a display which only supports smaller resolutions, you will need to configure the output resolution to match.

This is performed using the hotkey combination: *L Ctrl | L Ctrl | F11 | d | #*

where # represents the desired resolution:

- 1 = 2048 x 2048
- 2 = 2560 x 1440
- 3 = 2560 x 1600
- 4 = 1920 x 1080
- 5 = 1920 x 1200
- 6 = 3840 x 1080
- 7 = 3440 x 1440
- 8 = 3840 x 2160

The above hotkey function is particularly useful if the output display is unable to display the default resolution and you cannot view the OSD menu.

## GENERAL CONFIGURATION

The configuration of your multi-viewer switch is achieved through the OSD:

- *Video Settings*, including output resolution, scaling, borders, preset selection, etc.
- *Channel Settings*, including front panel display channel names and security levels, front panel button colors etc.
- *USB Settings*, including mouse configuration and hotkey choice.
- *Audio Settings*, including audio mixing and volume levels.
- *Advanced Operation*, including factory reset.

To access the OSD menu, type: *L Ctrl | R Ctrl | o*

The menu will appear in the bottom left part of the primary screen and you use your mouse to click the required options, with all changes being actioned upon exiting the OSD. See page 11.

## Using with dual head computers

Dual head computers (Windows or Linux) may be connected to channels 1+2 or 3+4. A video connection is required to each input channel, together with a single USB and audio connection to the primary channel (ie 1 or 3). Note: Dual-head Macs are not supported.

## Windows operation

In addition, a Windows 10 driver is required, which may be downloaded from [www.adder.com](http://www.adder.com).

On each multiple monitor computer, run the downloaded file. After accepting the licence agreement you will be prompted to choose a destination folder. Either accept the suggested location or change it, as necessary. No configuration is required.

## Linux operation

A video, USB and audio connection is required to each channel, primary and secondary. No drivers are required.

## USING THE OSD

The OSD deals with settings that may need to be occasionally changed after the initial commissioning process, such as video, channel and USB settings. The various options within the OSD are divided into five distinct pages.

### To enter the OSD

1 On the console keyboard, enter the following in succession:

- **Left Ctrl then Right Ctrl then o** (upper or lower case is accepted)

The menu will appear in the bottom left part of the primary screen.

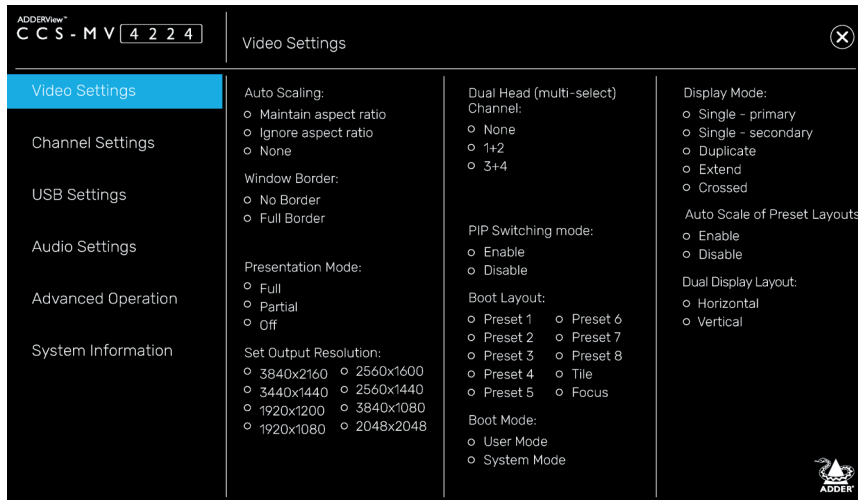

2 Use your mouse to click the required option(s). There is no Apply button, all changes are actioned as soon as you click an option.

### To exit the OSD

1 Click the **X** in the top right corner or press the Esc key.

## OSD pages

The OSD options are separated into five distinct pages:

- [Video Settings](#)
- [Channel Settings](#)
- [USB Settings](#)
- [Audio Settings](#)
- [Advanced Operation](#)
- [System Information](#)

## Channel names

The front panel display screen clearly shows the currently selected channel number (and audio channel) source(s). In addition, you can optionally choose to show a channel name:



Channel number and name plus audio source

Shown when remote control is connected

*Note: If the selected channel is connected to a dual head PC (see page 12), then a '+' symbol will be displayed next to the channel number, eg CH: 1+ ADDER\_01*

### To enter/edit a channel name

- 1 Access the OSD and select the Channel Settings page (see page 13).
- 2 Use the Channel Name option to enter the required name.

## Changing channel indicator colors

On the front panel there is a numbered button for each channel. To assist with visual feedback for the operator you can change the highlight color for each button that will be shown as each channel is selected. The same color choice will also be used on the optional remote control, when used as well as for each window border.

### To enter/edit a channel color

- 1 Access the OSD and select the Channel Settings page (see page 13).
- 2 Use the Channel Color option to select the required color.

## OSD - Video Settings

### To get here

- On the console keyboard, enter the following in succession:  
**Left Ctrl then Left Ctrl then o** (upper or lower case accepted)

### Auto Scaling

**Maintain aspect ratio** - The channel video aspect ratio will be maintained when the user resizes the window. This will result in a black bar being displayed where the window aspect ratio differs.

**Ignore aspect ratio** - This mode is best when you wish to manipulate display windows to fill blank space on the display canvas.

**None** - The channel video size and aspect ratio will remain the same regardless of the window size.

### Window Border

Defines whether a border is displayed for each channel window, or not. If displayed then the color of the border is determined by the Channel Color (see Channel Settings).

### Presentation Mode

This mode relates to the behavior when switching using the front panel buttons:

**Full** - When switching to a new channel from the front panel, it will be displayed in full screen.

**Partial** - Tile and full-screen mode will be used alternately when switching to a new channel will be used when switching to a new channel.

**Off** - When switching to a new channel, the currently selected method of presentation will be retained.

### Set Output Resolution

Choose the required output screen resolution. If two displays are connected, then the same resolution will be used for both.

**IMPORTANT:** Ensure that the display(s) support the desired output resolution. If not, the display will go blank. To resolve, change the output resolution using a hotkey: "L Ctrl | R Ctrl | D | # ", where # is 1 to 8.

ADDERView™  
C C S - M V 4 2 2 4

### Video Settings

- Video Settings
- Channel Settings
- USB Settings
- Audio Settings
- Advanced Operation
- System Information

**Auto Scaling:**

- Maintain aspect ratio
- Ignore aspect ratio
- None

**Window Border:**

- No Border
- Full Border

**Presentation Mode:**

- Full
- Partial
- Off

**Set Output Resolution:**

- 3840x2160
- 2560x1600
- 3440x1440
- 2560x1440
- 1920x1200
- 3840x1080
- 1920x1080
- 2048x2048

**Dual Head (multi-select) Channel:**

- None
- 1+2
- 3+4

**PIP Switching mode:**

- Enable
- Disable

**Boot Layout:**

- Preset 1
- Preset 2
- Preset 3
- Preset 4
- Preset 5
- Preset 6
- Preset 7
- Preset 8
- Tile
- Focus

**Boot Mode:**

- User Mode
- System Mode

**Display Mode:**

- Single - primary
- Single - secondary
- Duplicate
- Extend
- Crossed

**Auto Scale of Preset Layouts:**

- Enable
- Disable

**Dual Display Layout:**

- Horizontal
- Vertical

ADDER

### Dual Head (multi-select) Channel

Allows you to specify connection to 1 or 2 dual head PCs, rather than the default single head PCs. The default 'None' setting means that the input channels are treated as single head, but the channels 1+2 and 3+4 may be designated as dual heads. Please refer to page 10 for dual head connections.

### PIP Switching Mode

Picture in Picture mode. When enabled, the multi-viewer will switch to a small window inset within a larger window. When disabled, the mouse instead passes behind the inset window.

### Boot Layout

Determines which preset layout should be loaded at each power on boot.

### Boot Mode

In **User mode** you are interacting with the host computer, whereas in **System mode** you are interacting directly with the multi-viewer switch, for tasks such as moving or resizing windows.

### Display Mode

**Single - primary** - Video is only output to video port #1. This option should be used if only connecting a single display.

**Single - secondary** - Video is only output on video port #2. This option would be used if, say sharing a second display between 2 multi-viewers.

**Duplicate** - The secondary display is a duplicate of the primary.

**Extend** - The display extends across both the primary and secondary displays. You can move windows between displays and define presets that utilize the extended desktop.

**Crossed** - Similar to Extend, except that the primary and secondary displays are reversed. To uncross, select Extend mode.

### Auto Scale of Preset Layouts

When enabled, the preset layouts will fill the screen; if necessary, ignoring the aspect ratio. When disabled, the layout will respect the Auto Scaling setting.

### Dual Display Layout

Defines how your video displays are arranged:

**Horizontal** - The displays positioned side by side.

**Vertical** - The displays are arranged top and bottom.

## OSD - Channel Settings

### To get here

- 1 On the console keyboard, enter the following in succession:  
**Left Ctrl** then **Left Ctrl** then **o** (upper or lower case accepted)
- 2 Click the **Channel Settings** menu item.

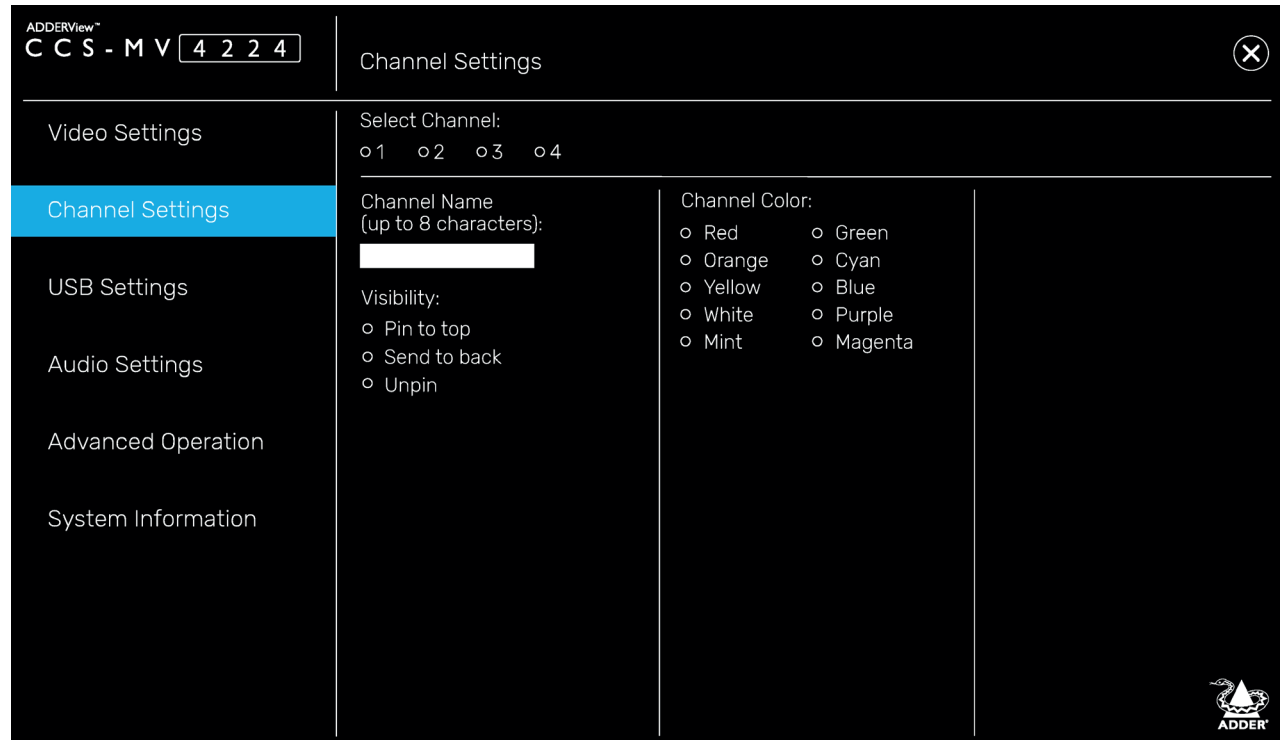

### Channel Name

Allows you to add a name for each channel. To do so: Select a channel number in the upper section, enter the name in the Channel Name field (up to 8 characters) and press Return.

### Visibility

By default, a window is unpinned, which means it may be located on top or behind other windows, as they are moved across the display. Alternatively, the window may be pinned to the top or sent to the back.

### Channel Color

On the front panel there is a numbered button for each channel. To assist with visual feedback for the operator you can change the highlight color for each button and window border color that will be shown as each channel is selected.

## OSD - USB Settings

### To get here

- 1 On the console keyboard, enter the following in succession:  
**Left Ctrl** then **Left Ctrl** then **o** (upper or lower case accepted)
- 2 Click the **USB Settings** menu item.

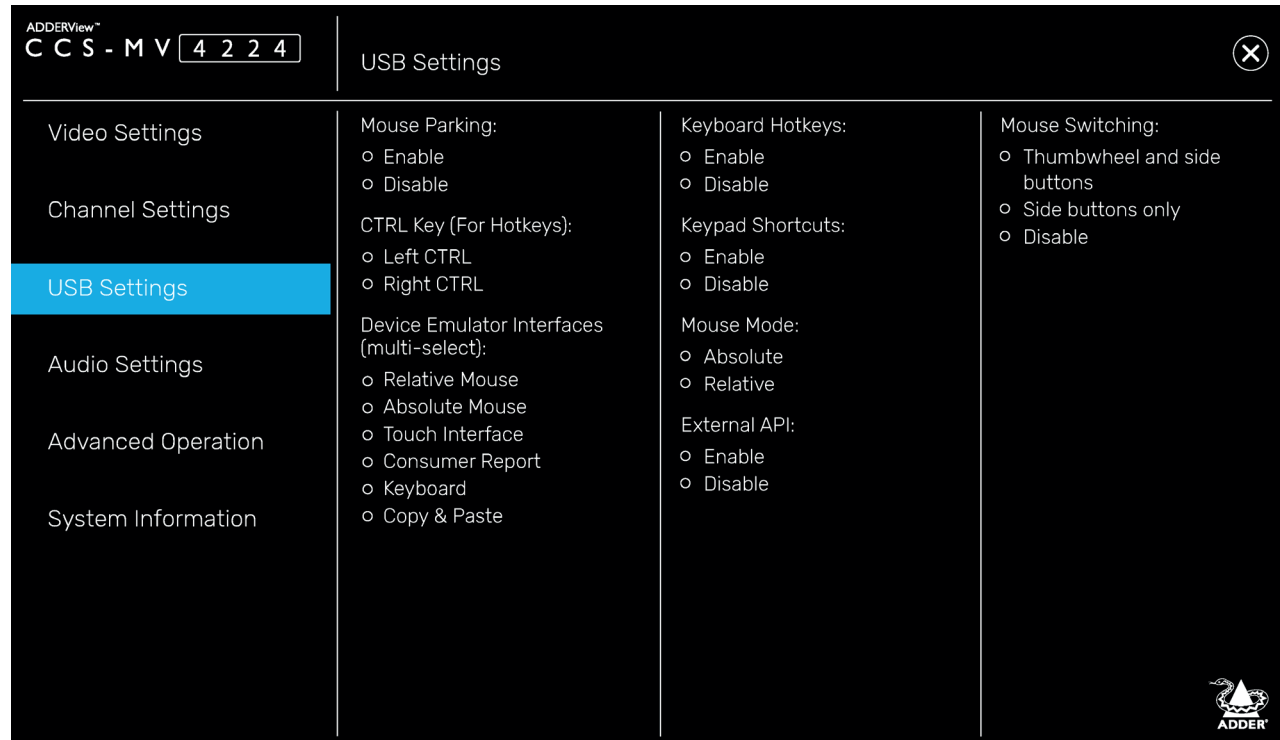

### Mouse Parking

Refers to hiding the mouse when the user moves to the other monitor.

### CTRL Key

Allows you to choose which Ctrl button on the keyboard that will be used as a hotkey.

### Device Emulator Interfaces

Specifies the user interface peripheral capabilities that are communicated to the host PC.

*Note: Consumer Report is a type of keyboard. Some versions of Linux do not support Absolute Mouse mode.*

*Note: Mac keyboards aren't supported, although the user may connect to a Mac host PC.*

### Keyboard Hotkeys

Determines whether keyboard hotkeys can be used.

### Keyboard Shortcuts

Reserved for future use.

### Mouse Mode

Defines the behavior of the multi-viewer system. Absolute mode is recommended for most users. Relative mode will disable mouse-based switching; leaving the front panel or hotkeys as the available switching methods.

*Note: Ensure that whichever Mouse Mode is selected, the corresponding Device Emulator setting is also enabled.*

### External API

Determines whether external API routines can be used.

### Mouse Switching

Determines which of the extra buttons of specially-equipped mouse devices can be used to switch channels.

## OSD - Audio Settings

### To get here

1 On the console keyboard, enter the following in succession:

**Left Ctrl** then **Left Ctrl** then **o** (upper or lower case accepted)

2 Click the **Audio Settings** menu item.

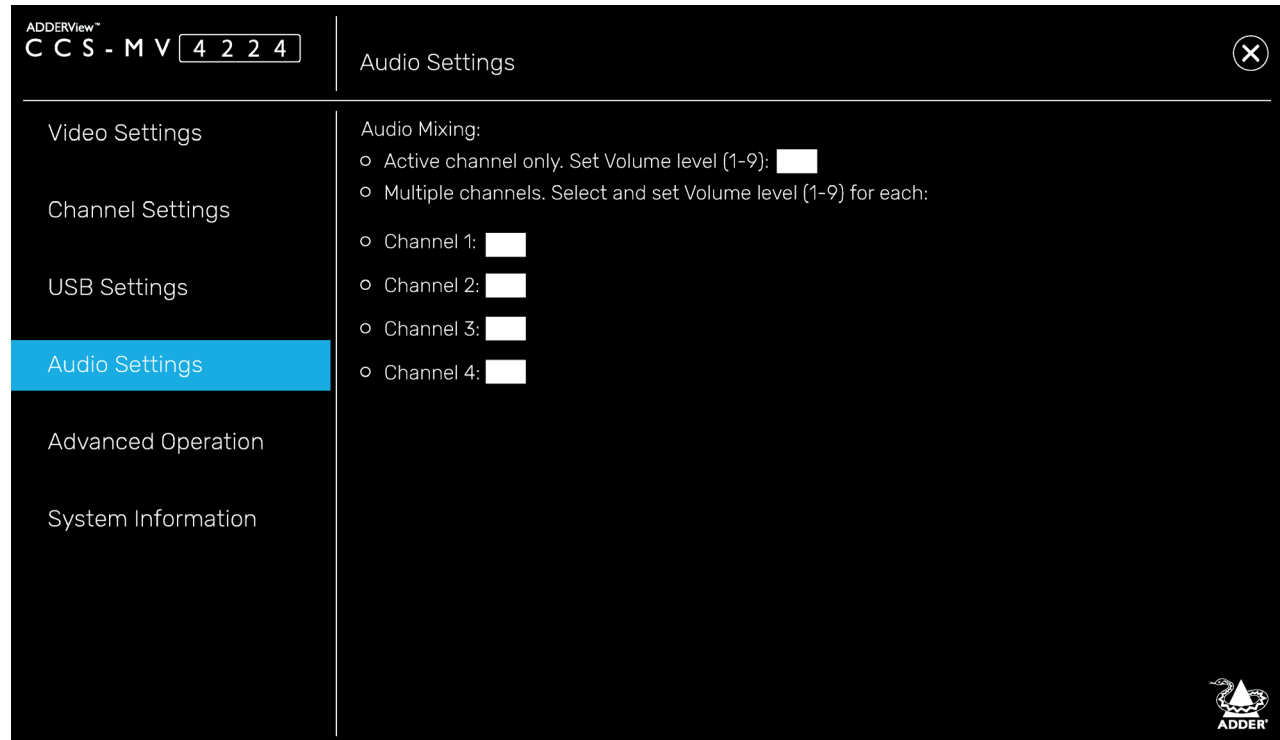

### Audio Mixing

It refers to output only and only applies to digital audio from the HDMI port.

*Note: Analog audio is always to single channel; either selected or on-hold.*

The front panel audio Hold button only applies to analog audio.



## OSD - Advanced Operation

### To get here

- 1 On the console keyboard, enter the following in succession:  
**Left Ctrl then Left Ctrl then o** (upper or lower case accepted)
- 2 Click the **Advanced Operation** menu item.

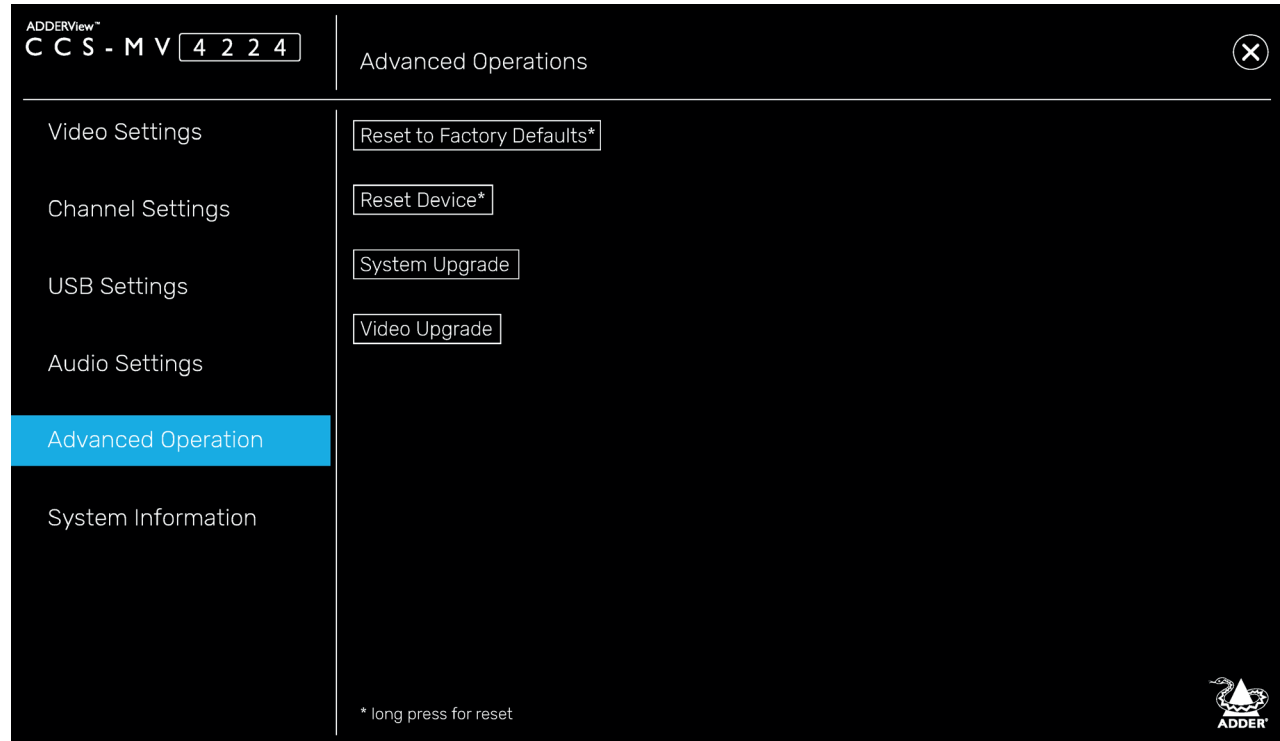

### Reset to Factory Defaults

Removes all user entered configuration details. This operation cannot be undone.

*Note: To avoid accidental resets, press and hold (for roughly 4 seconds).*

### Reset Device

Effectively reboots the multi-viewer.

*Note: To avoid accidental resets, press and hold (for roughly 4 seconds).*

### System Upgrade / Video Upgrade

Initiate either System or Video FPGA firmware upgrades. The label will blink whilst the upgrade is in progress. See page 20 for a description of the upgrade procedure.

## OSD - System Information

### To get here

1 On the console keyboard, enter the following in succession:

**Left Ctrl** then **Left Ctrl** then **o** (upper or lower case accepted)

2 Click the **System Information** menu item.

The screenshot shows the ADDERView OSD interface. At the top left, it displays 'ADDERView™' and 'C C S - M V 4 2 2 4'. The main title is 'System Information'. On the left side, there is a vertical menu with the following items: 'Video Settings', 'Channel Settings', 'USB Settings', 'Audio Settings', 'Advanced Operation', and 'System Information' (which is highlighted in blue). On the right side, the following information is displayed: 'System Type:', 'System Controller:', 'FPGA:', 'Video Controller:', and 'Front Panel:'. The ADDER logo is visible in the bottom right corner of the OSD window.

This page is intended to aid technical support. It displays the version number for the System and Video Controllers, plus Front Panel firmware. It also displays the Video FPGA version and System Type: (Secured or Commercial).

## COPY & PASTE

The optional Copy & Paste function enables seamless, high-speed copying of files and text from one Windows 10 computer to another. For details about using this feature, please see page 24.

There are two ways to use the Copy & Paste function:

Mode 1: *Using the internal COM Device* - used for transferring only text, up to 1,000 characters and requires no external storage device.

Mode 2: *Using an external USB Device* - can transfer files as well as text.

To use either of these options, you first need to download and install a small driver file onto all computers that are required to use the Copy & Paste function. You then need to enable the required mode: *COM Device* (see right) or *USB Device* (see page 19).

## Installing the Copy & Paste driver

This stage needs to be carried out regardless of the chosen mode.

### To install the driver

1 Connect the computers and user peripherals to the various ports of the multi-viewer switch, as discussed earlier in this chapter.

*Note: Ensure all devices and computers are connected prior to powering the multi-viewer switch on. Some devices, such as user displays, are not recognized if connected after the switch is already powered on.*

2 Download the Copy & Paste driver file from the Adder website:  
[www.adder.com](http://www.adder.com)

3 Install the driver file separately onto each computer that will use the Copy & Paste function. Once the software has been installed successfully, a software shortcut will appear on the desktop and a setup icon will appear on the taskbar of each computer.

4 You now need to enable the required Copy & Paste option:

- COM device uses the multi-viewer COMputer on-board memory (see right).
- USB device uses an external USB memory device (flash drive) for copying larger amounts of data - see page 19.

## Enabling the COM Device mode

(If you wish to enable the USB Device mode, see the next page.)

This mode allows you to copy & paste up to 1,000 plain text characters using the switch's memory for storage. It is designed to support the quick transfer of short text information between sources, such as telephone numbers, emails, web links, etc.

### To enable the COM Device mode

1 Carry out these steps once on **just one** of the host computers:

- Open the Notepad app (or any other text editor) and press:  
**Left Ctrl then Right Ctrl then t** (upper or lower case is accepted)
- Ignore the menu text that appears and press:  
**Left Ctrl then Right Ctrl then x**
- Close the Notepad app.

2 Carry out these steps on **every** computer that will use the Copy & Paste function:

- Press: **Left Ctrl then Right Ctrl then q**
- From the taskbar on the desktop, locate the setup icon, and right-click on it to open the menu below:

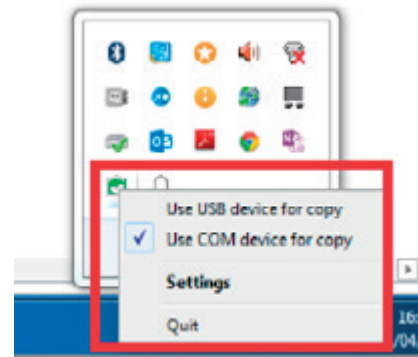

- Click Settings and in the window that opens, click Show advanced settings.
- From the additional tabs that open, choose the COM Device tab.
- In the window that opens, tick the Use COM Device checkbox and click OK.

## Enabling the USB Device mode

This mode allows you to copy & paste text and files using an external USB storage device as the temporary memory. Each host computer must have a USB link between it and the switch.

### To enable the USB Device mode

- 1 Connect an external FAT32-formatted USB storage device to one of the USB 3.0 Console ports on the rear panel of the switch. This USB storage device should appear on the computer's drivers list.
- 2 On **every** computer that will use the Copy & Paste function:

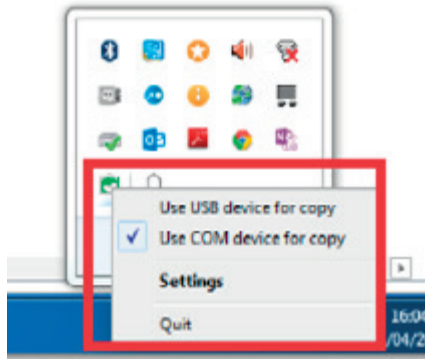

- a On the taskbar, locate the setup icon and right-click on it to open the menu below:

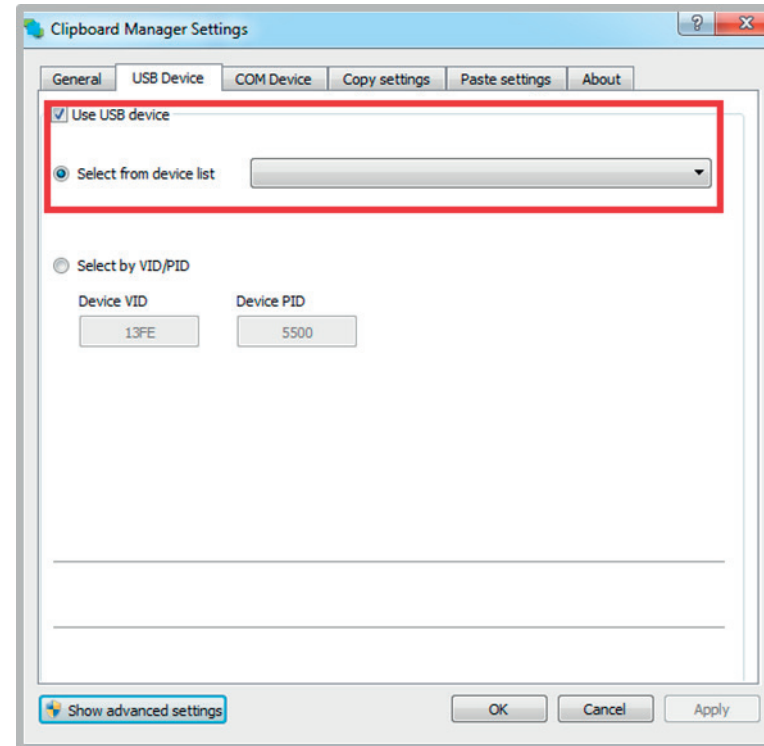

- b Click the Settings option and then click Show advanced settings.
- c Click the USB Device tab.
- d Select the Use USB Device checkbox.
- e From the Select from device list, select the USB storage device.
- f Click OK.

## CCS-MV UPGRADE PROCESS

- 1 Download and install Adder CCS-MV Firmware Upgrade tool from Adder.com on a PC not connected to the multi-viewer switch.
- 2 Power up the multi-viewer and open the OSD (Left Ctrl | Right Ctrl | O).
  - a For System Firmware upgrade select “Advanced operations” -> “System Upgrade”.
  - b For Video Firmware upgrade select “Advanced operations” -> “Video Upgrade”.
- 3 An “Upgrade” message will be displayed on the unit’s front panel. The selected option is shown as blinking on the OSD.  
 Note: Only one firmware may be upgraded at a time. Repeat the process if both upgrades are required.
- 4 Connect a USB A to A cable from the PC to the unit’s upper K/M port.
- 5 Open the Upgrade Tool and configure as follows:

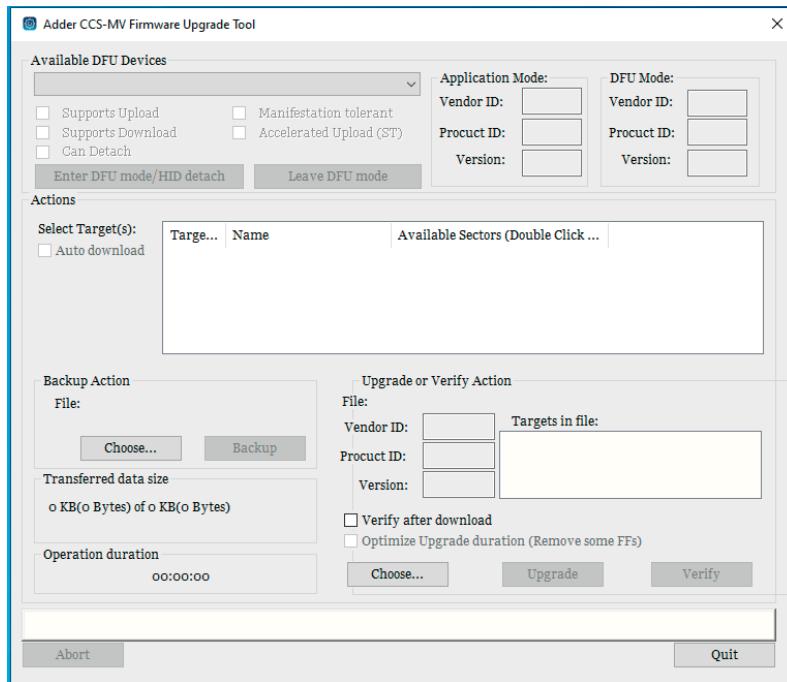

- a Select “STM Device in DFU mode” under “Available DFU Devices”.
  - b Within the “Upgrade or Verify Action” section press “Choose...” to select the firmware file.
  - c Select “Upgrade” to initiate the process. The progress bar will then indicate progress.
- 6 Wait for the upgrade process to be completed, whereupon a “Verify complete” message will appear on the progress bar.
- 7 Power cycle the unit.

## Troubleshooting

Issue	Remedy
“STM Device in DFU mode” does not appear.	<ol style="list-style-type: none"> <li>1 Check the driver installation under C:\Program Files (x86)\Adder Technology\Firmware Upgrade Tool\Drive\X86</li> <li>2 Install the driver: STtube30.sys manually.</li> <li>3 “STM Device in DFU Mode” should now reported under serial bus controllers in Device Manager.</li> </ol>
System upgrade incomplete.	<ol style="list-style-type: none"> <li>1 Disconnect the USB A to A cable.</li> <li>2 Power cycle the unit, whilst at the same time depress the channel 1 and channel 4 buttons simultaneously on the front panel.</li> <li>3 The unit will enter upgrade mode, whereby an “Upgrade” message is displayed on the front panel.</li> <li>4 Repeat the upgrade process from step #4.</li> </ol>
Video FPGA upgrade incomplete.	<ol style="list-style-type: none"> <li>1 Disconnect the USB A to A cable.</li> <li>2 Enter the hotkey Left Ctrl Right Ctrl Ins 2.</li> <li>3 The unit will enter upgrade mode, whereby an “Upgrade” message is displayed on the front panel.</li> <li>4 Repeat the upgrade process from step #4.</li> </ol>
FW doesn’t initiate properly. Error code 0xC000007B or “mfc140.dll missing” message.	Download and install Microsoft Visual C++ Redistributable 2015-2019 (x86), which can be found at: <a href="https://docs.microsoft.com/en-us/cpp/windows/latest-supported-vc-redist?view=msvc-170">https://docs.microsoft.com/en-us/cpp/windows/latest-supported-vc-redist?view=msvc-170</a>

The multi-viewer switch allows the user to view the video outputs of up to four host computers simultaneously, either on a single display or dual displays. Keyboard and mouse control is assigned to a single host computer at a time and is switchable using a number of methods (see page 22).

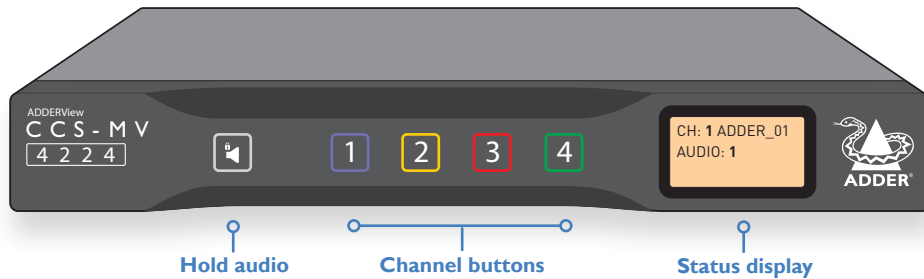

## Audio Hold

The Audio Hold button prevents switching the audio port when changing the other console peripherals (keyboard, mouse, video) to another computer channel. This function is useful when you need to listen to the audio from one computer while working on another.



Using the front panel computer channel buttons, first connect the console peripherals to the computer from where the audio feed is required. Press the Audio Hold button on the front panel. Then press the channel button for the computer that is required for the other peripherals. The audio association will be signalled by the right indicator on each channel's front panel push button.

To release the audio from hold status, press the Audio Hold button again.

## Status display

The status display shows the current channel number; the channel from which audio is being derived and also the remote control unit status.



## DISPLAYING WINDOWS

You can choose how to view the windows of the various host computers.

### Full screen

Shows a single window on the whole screen.

- On the keyboard, press and release: **L Ctrl | L Ctrl | f**

Note: This means press and release the following keys:

**Left Ctrl then Left Ctrl then f**

For dual displays, it applies to the screen with cursor focus.



### Tile (quadrant) layout

Shows four windows on the display in a quadrant.

- On the keyboard, press and release: **L Ctrl | L Ctrl | q**



### Focus layout

One window is shown at a larger size with the other windows scaled down and located on the right-hand side of the screen.

- Press: **L Ctrl | L Ctrl | s**

Select System mode and then rotate the mouse thumbwheel to move the focus between the windows. If thumbwheel switching is disabled (see USB Settings page 14), then either select focus channel from front panel or window within System mode.



### Custom layouts

If custom layouts have been saved (see page 23), you can select one as follows:

- Press: **L Ctrl | L Ctrl | F#** (where F# is the required function key: F1 to F8)

### Dual displays

When dual displays are used in Extend Display Mode (page 12), the secondary display will remain blank until you drag a window on it or select a preset layout that uses it. The Focus layout is recommended for dual displays, as per the diagram to the right.

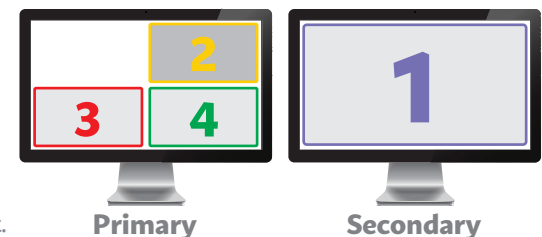

## SWITCHING BETWEEN CHANNELS

- Press the required channel button on the front panel:

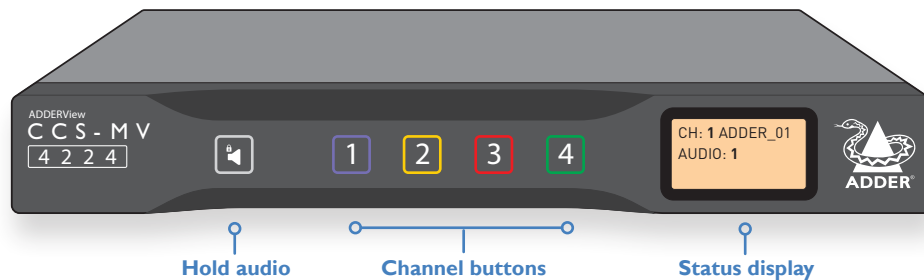

- In any of the multi-view layouts, simply move the mouse cursor across the boundaries of the display windows\*.

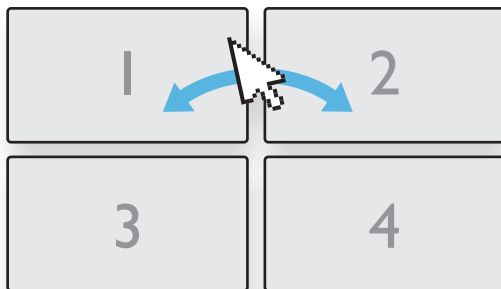

\*The mouse method relies on absolute mouse mode, which can be enabled and disabled by the user to match their own preferences and to ensure compatibility with their computers.

To use absolute mouse mode, press: `L Ctrl | L Ctrl | F11 | c`

To use relative mouse mode, press: `L Ctrl | L Ctrl | F11 | b`

In Relative mouse mode, channel switching is restricted to either the front panel buttons or the scrolling the mouse thumbwheel.

## MANAGING WINDOWS

In everyday use, the multi-viewer switch has two main modes of operation:

- **User mode** - this is the normal mode of operation, where the switch is essentially transparent. This means that your commands pass straight through to interact with the host PC(s), as if you were directly connected to them.
- **System mode** - in this mode, your link with the PC(s) is temporarily suspended and instead you interact directly with the switch. This allows you to perform certain tasks, such as resizing windows and arranging preset layouts.

It is quick and easy to change between the two modes, as follows.

### Entering and exiting system mode

#### To enter system mode

- On the keyboard, press and release the following: **Left Ctrl then Left Ctrl then o**  
*Note: In the pages that follow, such sequences are shown in the form: `L Ctrl | L Ctrl | o` or*
- On the mouse, either click the scroll wheel, or for a five-button mouse, select either of the side buttons. *Note: The mouse must be set to use Absolute Mode (see page 14).*

Within system mode you will see a large blue cursor; in this mode keyboard strokes and mouse movements are not transmitted to the computers, but instead are interpreted within the multi-viewer switch.

#### To return to user mode

- Press `L Ctrl | L Ctrl | u` to return to user mode.  
*or*
- On the mouse, either click the scroll wheel, or for a five-button mouse, select either of the side buttons.

### Taking control of a window

- 1 In a multi-window layout, enter System Mode, as described above.
- 2 Move the large blue cursor to the window that you wish to take control.
- 3 Now, either:
  - Take control of the chosen window at the current size: Click the scroll wheel.
  - or*
  - Maximise and take control of the chosen window: Double click the left mouse button.

In either case, you will revert to user mode with control of the selected computer.

## Custom Preset Layouts

In system mode, the mouse cursor is also responsible for re-sizing and moving windows around within the display canvas. It is advisable to begin with one of the predefined layouts and adjust it to suit your requirements. These layouts can be selected before or after entering system mode:

- For **tile layout**, use the hotkey combination: `L Ctrl | L Ctrl | q`
- For **focus layout**, use the hotkey combination: `L Ctrl | L Ctrl | s`
- For a **custom layout**, use the hotkey combination: `L Ctrl | L Ctrl | F#`  
(where *F#* is the required function key: *F1* to *F8*)

Manipulate the windows to the desired sizes and locations, then apply the new layout to a function key: `L Ctrl | L Ctrl | F1 | Ins | F#`  
(where *F#* is the required function key: *F1* to *F8*).

Once you have exited system mode, you will be able to switch between the predefined tile and focus layouts as well as recall your own custom presets.

## Resizing and moving windows

There are a number of options available when resizing windows, including the options to retain the aspect ratio or select only a partial element of the computer's display.

### To use autoscaling

The autoscaling feature allows selected windows to fill the screen, either respecting or overriding the aspect ratio, depending on the selected option. Autoscaling can be enabled either through the OSD menu or by using the following hotkey combinations:

- To enable autoscaling with aspect ratio maintained: `L Ctrl | L Ctrl | F1 | w | w`
- To enable autoscaling without aspect ratio being maintained: `L Ctrl | L Ctrl | F1 | w | y`
- To disable autoscaling: `L Ctrl | L Ctrl | F1 | w | n`

With your preferred scaling option selected, windows can now be manipulated using the blue mouse cursor.

### To move a window

Locate the blue mouse cursor anywhere within the window. Press and hold the left mouse button and drag the window to your desired location. Release the left mouse button.

### To resize a window

Place the blue mouse cursor at the lower-right corner of the required window. Press and hold the right mouse button and drag to resize the window up or down accordingly. Release the right mouse key when the window is at the desired size.

Depending on the current autoscaling setting, the video will (or won't) adjust in size and/or aspect ratio. To force the source to rescale within the defined window you can use either of the following:

- To fill with a fixed aspect ratio: `L Ctrl | L Ctrl | F1 | w`
- To fill with a non-fixed aspect ratio: `L Ctrl | L Ctrl | F1 | y`



## USING COPY & PASTE

The optional Copy & Paste function allows you to copy text and files from one host PC to another.

There are two ways to use the Copy & Paste function:

Mode 1: *Using the internal COM Device* - used for transferring only text, up to 1,000 characters and requires no external storage device.

Mode 2: *Using an external USB Device* - can transfer files as well as text.

### Initial configuration

To use the Copy & Paste function, you will first need to download and install a small driver file onto all computers that are required to use the function. You will also need to choose which mode you wish to use. Please see **page 18** for details.

### Using the COM Device mode

Allows you to Copy & Paste up to 1,000 plain text characters using the switch's memory for storage. It is designed to support the quick transfer of short text information between sources, such as telephone numbers, emails, web links, etc.

#### To use the COM Device mode

- 1 On the source computer, highlight the text (up to 1,000 characters) and perform a standard copy function using the mouse or keyboard. The copied text is stored within the switch's local memory.
- 2 Switch to the target computer and perform a standard paste function to the desired location. The text is copied as plain text, with no formatting parameters.

*Note: A small pop-up window on the taskbar provides status updates once text is copied or available for paste on a specific computer. The last copied data will remain stored in memory, until any other copy function is performed. This allows you to paste the same text on several computers.*

### Using the USB Device Mode

The USB Device mode uses an external USB storage device to store copied data and allows you to copy & paste both text and files from one computer to another (up to 999Mb). It is designed to support large text and file copying between sources.

#### To use the USB Device mode

- 1 On the source computer, highlight the desired text or choose a file and perform a standard copy function using the mouse or keyboard. The copied data is stored on the external USB storage device.
- 2 Switch to the target computer and perform a standard paste function via the mouse or keyboard to the desired location.

The last copied data will be retained within the USB storage device (until such time as it is replaced by another copy action) so that you can paste pasting the same data on several computers.

*Note: When moving to a specific computer, the "USB External Storage Auto-run" pop-up message will appear. It is possible to disable this in the configuration options.*

# Further information



This chapter contains a variety of information, including the following:

- Getting assistance - see right
- [Appendix A](#) - Hotkey commands
- [Appendix B](#) - Open Source Licenses

## GETTING ASSISTANCE

If you are still experiencing problems after checking the information contained within this guide, then please refer to the Support section of our website:

[www.adder.com](http://www.adder.com)

INSTALLATION

CONFIGURATION

OPERATION

FURTHER  
INFORMATION

INDEX

## APPENDIX A - Hotkey commands

This section provides a summary of hotkey commands used on the multi-viewer switch.

*Note: The hotkeys assume the use of a US keyboard.*

### To invoke the OSD

Press and release **Left Ctrl** then **Right Ctrl** then **o**

### To invoke the video FPGA upgrade mode

Press and release: **Left Ctrl** then **Right Ctrl** then **INS 2**

### Other commands

Press and release: **Left Ctrl** then **Left Ctrl** then:

User mode	u
Maximize window to full-screen	f
Tile window layout (quad view)	q
Focus window layout	s
Increase window scaling	+
Reduce window scaling	-
Set output display resolution	F11 d# (where # is 1 to 8)
• 1 = 2048 x 2048	
• 2 = 2560 x 1440	
• 3 = 2560 x 1600	
• 4 = 1920 x 1080	
• 5 = 1920 x 1200	
• 6 = 3840 x 1080	
• 7 = 3440 x 1440	
• 8 = 3840 x 2160	

Unpin all windows	F11 f r
Pin/unpin window toggle (where # is the required function key: F1 to F8)	F11 F#
PiP mode toggle	F11 INS p
Load presets 1..8	F1..F8
Save preset 1..8	F11 INS F1..F8
Relative mouse mode	F11 b
Absolute mouse mode	F11 c
Presentation mode off	F11 n
Presentation mode on	F11 p
Reset to factory defaults	F11 r
Reboot unit	F11 INS r
Fix aspect ratio	F11 w
Non-fixed aspect ratio	F11 y
Enable autoscaling with aspect ratio maintained	F11 w w
Enable autoscaling without aspect ratio maintained	F11 w y
Disable autoscaling	F11 w n
Increase mouse speed	F11 +
Reduce mouse speed	F11 -

Move and resize window F11 End <Channel> <Operation> <Percent>

Refer to the API Manual (MAN-0000023) for further details

## APPENDIX B – OPEN SOURCE LICENSES

This product includes binaries that are derived from the open source community.

STMicroelectronics SLA0048 - Rev 4 (March 2018)

Under STMicroelectronics' intellectual property rights and subject to applicable licensing terms for any third-party software incorporated in this software package and applicable Open Source Terms (as defined here below), the redistribution, reproduction and use in source and binary forms of the software package or any part thereof, with or without modification, are permitted provided that the following conditions are met:

- 1 Redistribution of source code (modified or not) must retain any copyright notice, this list of conditions and the following disclaimer.
- 2 Redistributions in binary form, except as embedded into microcontroller or microprocessor device manufactured by or for STMicroelectronics or a software update for such device, must reproduce the above copyright notice, this list of conditions and the following disclaimer in the documentation and/or other materials provided with the distribution.
- 3 Neither the name of STMicroelectronics nor the names of other contributors to this software package may be used to endorse or promote products derived from this software package or part thereof without specific written permission.
- 4 This software package or any part thereof, including modifications and/or derivative works of this software package, must be used and execute solely and exclusively on or in combination with a microcontroller or a microprocessor devices manufactured by or for STMicroelectronics.
- 5 No use, reproduction or redistribution of this software package partially or totally may be done in any manner that would subject this software package to any Open Source Terms (as defined below).
- 6 Some portion of the software package may contain software subject to Open Source Terms (as defined below) applicable for each such portion ("Open Source Software"), as further specified in the software package. Such Open Source Software is supplied under the applicable Open Source Terms and is not subject to the terms and conditions of license hereunder.  
"Open Source Terms" shall mean any open source license which requires as part of distribution of software that the source code of such software is distributed therewith or otherwise made available, or open source license that substantially complies with the Open Source definition specified at [www.opensource.org](http://www.opensource.org) and any other comparable open source license such as for example GNU General Public License (GPL), Eclipse Public License (EPL), Apache Software License, BSD license and MIT license.
- 7 This software package may also include third party software as expressly specified in the software package subject to specific license terms from such third parties. Such third party software is supplied under such specific license terms and is not subject to the terms and conditions of license hereunder. By installing copying, downloading, accessing or otherwise using this software package, the recipient agrees to be bound

by such license terms with regard to such third party software.

- 8 STMicroelectronics has no obligation to provide any maintenance, support or updates for the software package.
- 9 The software package is and will remain the exclusive property of STMicroelectronics and its licensors. The recipient will not take any action that jeopardizes STMicroelectronics and its licensors' proprietary rights or acquire any rights in the software package, except the limited rights specified hereunder.
- 10 The recipient shall comply with all applicable laws and regulations affecting the use of the software package or any part thereof including any applicable export control law or regulation.
- 11 Redistribution and use of this software package partially or any part thereof other than as permitted under this license is void and will automatically terminate your rights under this license.

THIS SOFTWARE PACKAGE IS PROVIDED BY STMICROELECTRONICS AND CONTRIBUTORS "AS IS" AND ANY EXPRESS, IMPLIED OR STATUTORY WARRANTIES, INCLUDING, BUT NOT LIMITED TO, THE IMPLIED WARRANTIES OF MERCHANTABILITY, FITNESS FOR A PARTICULAR PURPOSE AND NON-INFRINGEMENT OF THIRD PARTY INTELLECTUAL PROPERTY RIGHTS ARE DISCLAIMED TO THE FULLEST EXTENT PERMITTED BY LAW. IN NO EVENT SHALL STMICROELECTRONICS OR CONTRIBUTORS BE LIABLE FOR ANY DIRECT, INDIRECT, INCIDENTAL, SPECIAL, EXEMPLARY, OR CONSEQUENTIAL DAMAGES (INCLUDING, BUT NOT LIMITED TO, PROCUREMENT OF SUBSTITUTE GOODS OR SERVICES; LOSS OF USE, DATA, OR PROFITS; OR BUSINESS INTERRUPTION) HOWEVER CAUSED AND ON ANY THEORY OF LIABILITY, WHETHER IN CONTRACT, STRICT LIABILITY, OR TORT (INCLUDING NEGLIGENCE OR OTHERWISE) ARISING IN ANY WAY OUT OF THE USE OF THIS SOFTWARE PACKAGE, EVEN IF ADVISED OF THE POSSIBILITY OF SUCH DAMAGE.

EXCEPT AS EXPRESSLY PERMITTED HEREUNDER AND SUBJECT TO THE APPLICABLE LICENSING TERMS FOR ANY THIRD-PARTY SOFTWARE INCORPORATED IN THE SOFTWARE PACKAGE AND OPEN SOURCE TERMS AS APPLICABLE, NO LICENSE OR OTHER RIGHTS, WHETHER EXPRESS OR IMPLIED, ARE GRANTED UNDER ANY PATENT OR OTHER INTELLECTUAL PROPERTY RIGHTS OF STMICROELECTRONICS OR ANY THIRD PARTY.

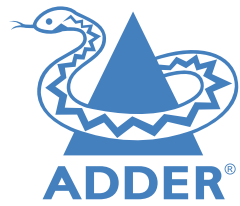

[www.adder.com](http://www.adder.com)

Documentation by:



[www.ctxd.com](http://www.ctxd.com)

© 2022 Adder Technology Limited  
All trademarks are acknowledged.  
Part No. MAN-000009 • Release 1.1

- A**
  - Advanced Settings 16
  - Audio Hold 21
  - Audio Settings 15
  - Autoscaling 23
- C**
  - Channel button
    - colors 11
  - Channel name 11
  - Channels
    - switching between 22
  - Channel Settings 13
  - Colors
    - button indicators 11
  - Connections 6
    - computer 7
    - console 8,9
    - overview 6
    - power 9
    - remote control unit 9
  - Copy & Paste
    - configuring 18
    - using 24
- D**
  - Displays
    - initial setup 10
- F**
  - Focus layout 21
- H**
  - Hotkeys 26
- O**
  - On Screen Display (OSD) 11
- P**
  - Ports 6
  - Power in 9
  - Preset layouts 23
- Q**
  - Quadrant. *See* Tile layout
- S**
  - Settings
    - audio 15
    - channel 13
    - USB 14
    - video 12
  - Software upgrade 20
  - Speakers 8
  - Specifications 3
- T**
  - Technical specifications 3
  - Tile layout 21
- U**
  - Upgrade 20
  - USB Settings 14
- V**
  - Video Settings 12
- W**
  - Window configurations 21
  - Windows
    - managing 22
    - resizing and moving 23