

M4350 IT and AV Managed Switches

Designed for the most demanding AV over IP installations of up to thousands of endpoints. The M4350 brings all the simplicity from the M4250 AV Line packed in more Enterprise-class hardware with redundant power supplies and larger fabrics with 25G and 100G uplinks. The revolutionary NETGEAR AV user interface and Engage™ Controller contain pre-configured profiles for all major audio, video, and lighting protocols.

NETGEAR® AV



NETGEAR®
BUSINESS



AV Target Application

Core

At the core, two powerful M4350 models can be stacked*. For maximum performance, and best reliability, two switches should be the limit

- Management unit hitless failover and nonstop forwarding ensure no single point of failure
- The interconnect should provide headroom: for instance, all the multicast present in the network will be replicated between the two core switches

Building 1 to 5

- Each M4350 model connects to the core using distributed link aggregation (LACP, fully automatic with Auto-LAG and Auto-Trunk)
- In case of one core switch failure, there is no service interruption

Centrally managed by the NETGEAR Engage™ Controller

- Simplify your AV multicast deployments with NETGEAR IGMP Plus™ which prevents any multicast flooding for your Professional AV, Medical AV, Residential AV, Broadcast AV, Lighting installations, and more.
- Centrally available in Engage, the revolutionary NETGEAR AV user interface contains pre-configured profiles for all major audio, video, and lighting protocols including: AVB, Dante, Q-SYS, AES67, NVX, AMX, Q-SYS, NDI 4, NDI 5, ZeeVee, Aurora Multimedia, Kramer, Atlona, LibAV, Visionary, SDVoE and others. SMPTE ST 2110 is supported on select models

* Stacking, AVB, and PTP TC are mutually exclusive features. A stack cannot run AVB, nor PTP TC (or BC/GM).

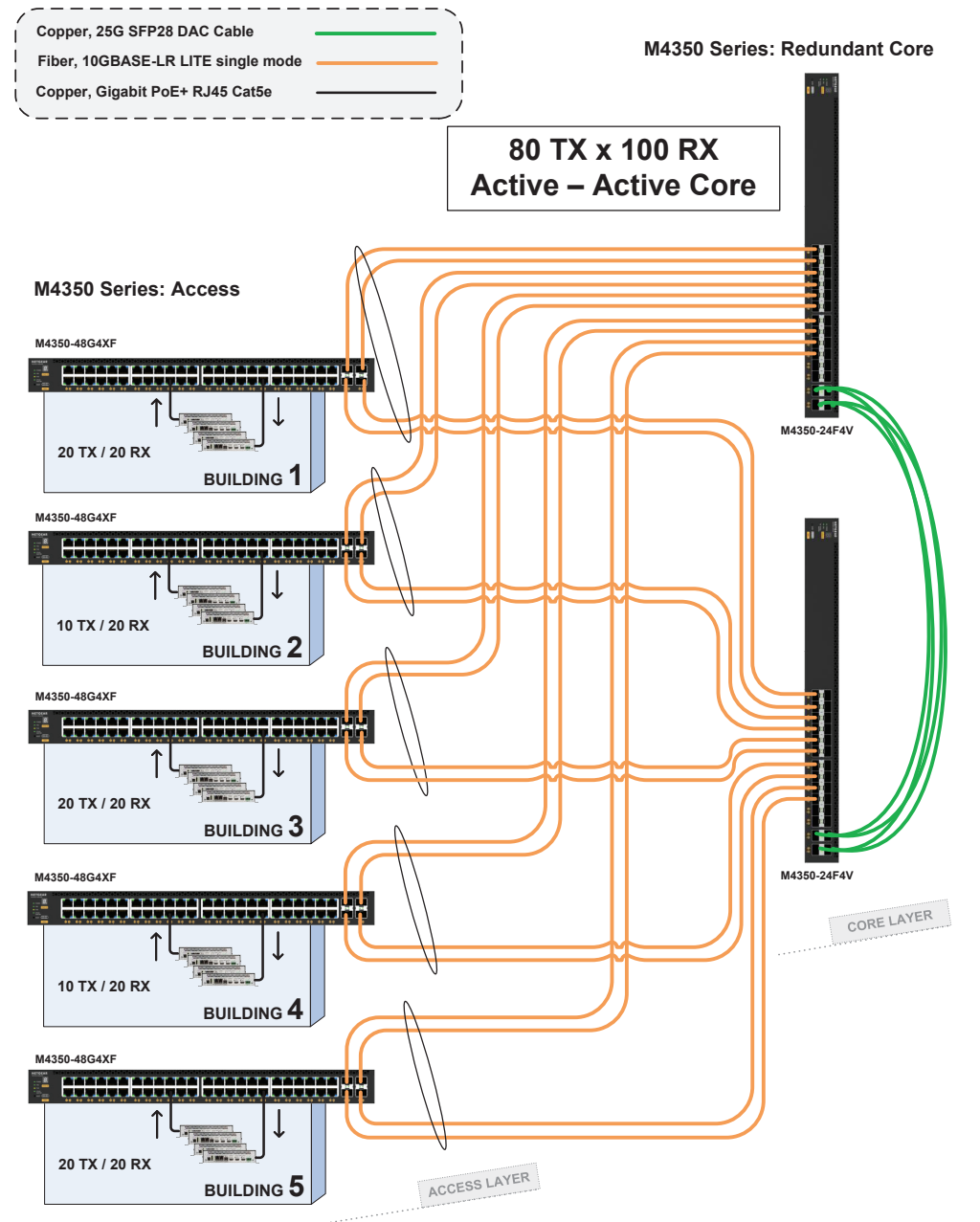

IT Target Application

Core

At the core, two powerful M4350 models can be stacked. For maximum performance, and best reliability, two switches should be the limit

- Management unit hitless failover and nonstop forwarding ensure no single point of failure
- The interconnect should provide headroom: for instance, all the multicast in the present network will be replicated between the two core switches

Building 1

- For midsize server installations, two half-width M4350 10GbE models can be paired in a single rack space for redundant top-of-rack
- Management unit hitless failover and nonstop forwarding ensure no single point of failure for servers and storage

Building 2

- Common for intermediate distribution frames (IDF) in K-12 and other large campuses, stacking topologies greatly simplify deployments at the edge
- While reducing the number of logical units to manage, stacking also brings network resiliency with distributed uplinks in aggregation to the core

Building 3

- For typical collapsed core installations, with a variety of 1G, 2.5G, 10G, and 25G access ports in branch offices, server rooms or campus high performance labs
- Double star architectures deliver highest performance with every leaf switch connecting to every spine switch

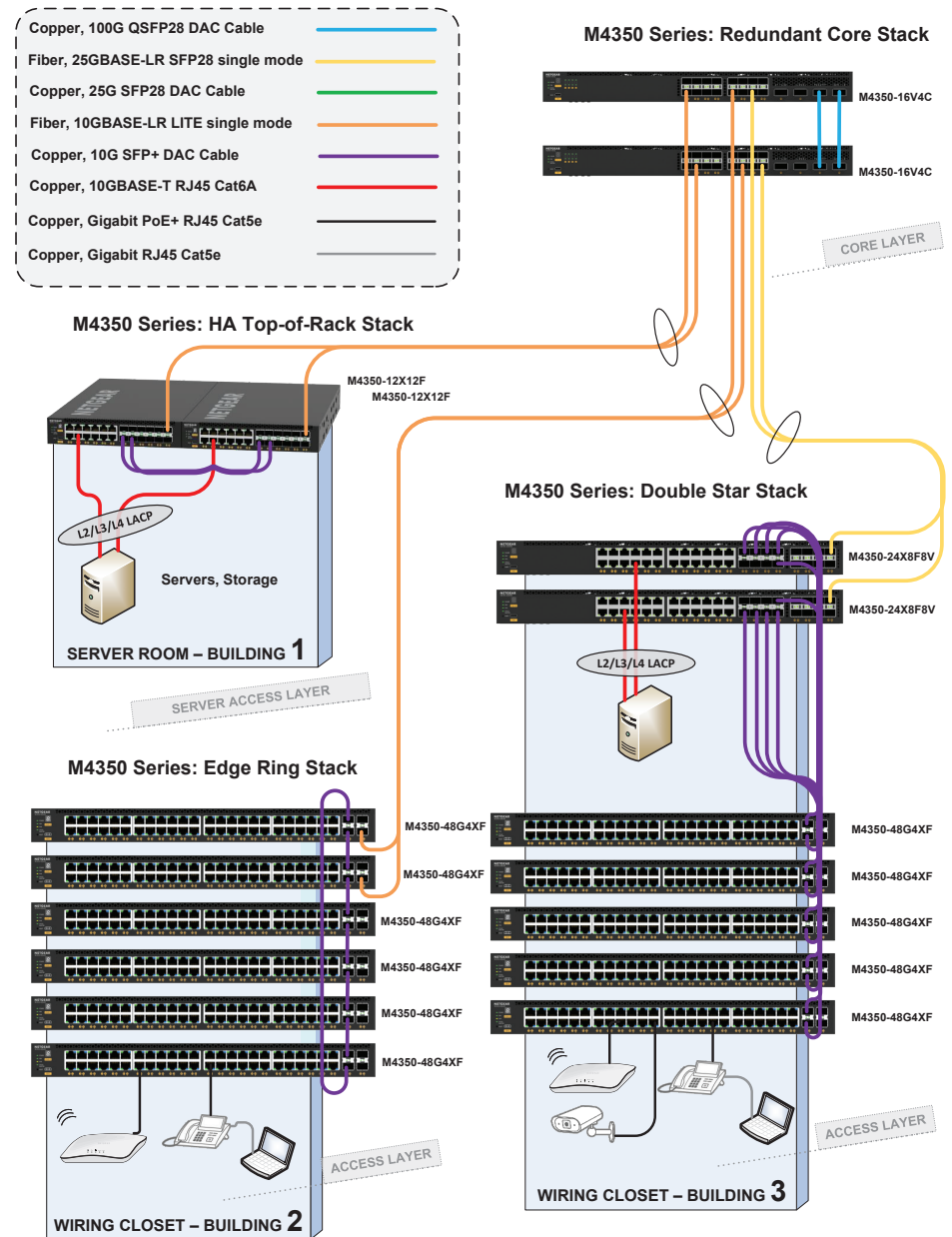

M4350 Series Features



The NETGEAR M4350 series is a versatile 1G, 2.5G, 10G, 25G, and 100G solution designed for the edge, the server room, and the core. M4350 delivers nonstop forwarding stacking, spine and leaf, edge to core connectivity for AV and IT networks. In AV environments, the AV User Interface, Engage Controller and AV profiles are certified by 200+ AV manufacturers.

NETGEAR M4350 series key features:

- Ranges from 1G to 100G with a variety of PoE+ and Ultra90 PoE++ options for 15.4W, 30W, 60W, 75W and 90W AVoIP endpoints
- Non-stop forwarding (NSF) provides advanced High Availability (HA) with hitless failover across the stack
- Entire feature set (L2 switching, L3 dynamic routing, time sensitive networking, AVB) available without license
- Low acoustics, half-width 16-port and 24-port 10G models can be paired in a single rack space for redundant Top of Rack
- For the IT team, only one platform from the edge to the core, one software to standardize on
- Redundant modular power supplies contribute to business continuity management
- Layer 3 feature set includes static and policy-based routing, RIP, VRRP, OSPF, and PIM dynamic routing

- No need for tradeoffs anymore between performance, reliability, HA, features, scale, futureproofing, complexity, or cost
- Front to back cooling, always within 40cm (15.7in) depth and controlled thermal and acoustics
- Intelligent fans configurable in Quiet Mode to minimize noise, or Cool Mode to minimize heat

NETGEAR M4350 series AV software features:

- Designed for the most demanding AV over IP installations of up to thousands of endpoints
- AV-centric User Interface allows for simple, profile-based, per-port configuration in a snap
- Works out of the box with automatic, multi-switch configuration for most AV-over-IP installs
- All the simplicity of the M4250 AV Line packed in more Enterprise-class hardware with redundant power supplies and larger fabrics with 25G and 100G uplinks

M4350 Series Features

- Less time to install and configure using the NETGEAR Engage™ Controller
- SMPTE ST 2110 supported on select models, always with the same simplicity from the AV UI
- NETGEAR IGMP Plus™ means AV-over-IP multicasting will work out of the box and not flood your network
- With Auto-Trunk and Auto-LAG, simply connect M4350 switches together and you are done!

NETGEAR M4350 series other software features:

- Static, RIP and PIM-SM, DM and SSM multicast routing, DHCP Server and PTPv2 Transparent Clock (1-step E2E)
- Advanced classifier-based, time-based hardware implementation for L2 (MAC), L3 (IP) and L4 (UDP/TCP transport ports) security and prioritization
- Selectable Port-Channel / LAG (802.3ad - 802.1AX) L2/L3/L4 hashing for fault tolerance and load sharing with any type of Ethernet channeling
- Voice VLAN with SIP, H323 and SCCP protocols detection and LLDP-MED IP phones automatic QoS and VLAN configuration
- Efficient authentication tiering with successive DOT1X, MAB and Captive Portal methods for streamlined BYOD
- Advanced IPv4/IPv6 security implementation including malicious code detection, DHCP Snooping, IP Source Guard protection and DoS attacks mitigation

NETGEAR M4350 series management features:

- DHCP/BootP innovative auto-installation including firmware and configuration file upload automation
- Industry standard SNMP, RMON, MIB, LLDP, AAA, sFlow, RSPAN and PTPv2

- Service port for out-of-band Ethernet management (OOB)
- USB Type-C port for local management console (unique NETGEAR driver for M4250/M4350)
- Standard USB-A ports for local storage, logs, configuration or image files
- Industry standard command line interface (CLI) for IT admins used to other vendors commands
- Fully functional Web console (main GUI) for IT admins who prefer an easy to use graphical interface
- Dedicated AV web-based GUI interface for AV installations

NETGEAR M4350 series warranty and support:

- NETGEAR ProSAFE Limited Lifetime Hardware Warranty**
- Included Lifetime Technical Support
- Included Lifetime Next Business Day Hardware Replacement
- Offering free network design services and installation support, the NETGEAR Engineering Services Team is ready to help ensure your 1G deployments with the M4350 switches go as smooth as possible. Just drop us an email at ProAVDesign@netgear.com to get started!



Hardware-at-a-Glance

Model Name	Form-Factor	Switching Fabric	FRONT						REAR			MANAGEMENT	Model Number	
			1000BASE-T RJ45 ports	2.5GBASE-T RJ45 ports	10GBASE-T RJ45 ports	10GBASE-X SFP+ ports	25GBASE-X SFP28 ports	100GBASE-X QSFP28 ports	Internal PSU	Modular PSU Bays	Fans	Out-of-band Console		
M4350-24G4XF	Full width 1U rack mount 440x43.2x400mm	128 Gbps	24 ports PoE+ 10M; 100M; 1G 648W (base) up to 720W	-	-	4 ports 1G; 10G	-	-	1 x Fixed 880W (C14) On/Off switch	1 slot	Fixed Front-to-back	Ethernet: Out-of-band 1G port (Back)	GSM4328	
M4350-48G4XF	Full width 1U rack mount 440x43.2x400mm	176 Gbps	48 ports PoE+ 10M; 100M; 1G 236W (base) up to 1,440W	-	-	4 ports 1G; 10G	-	-	1 x Fixed 550W (C14) On/Off switch	2 slots			GSM4352	
M4350-44M4X4V	Full width 1U rack mount 440x43.2x400mm	500 Gbps	-	44 ports PoE++*** 100M; 1G; 2.5G <--- 194W (base), up to 3,314W ---->	4 ports PoE++*** 100M; 1G; 2.5G; 5G; 10G	-	4 ports 1G; 10G; 25G (Ethernet Mode*) (Stacking: 25G**)	-	1 x Fixed 550W (C14) On/Off switch	2 slots			MSM4352	
M4350-8X8F	Half-width 1- or 2-unit 1U rack mount 220x43.2x400mm	320 Gbps	-	-	8 ports 100M; 1G; 2.5G; 5G; 10G	8 ports 1G; 10G	-	-	1 x Fixed 240W (C14) On/Off switch	-			Console: USB-C (Front)	XSM4316
M4350-12X12F	Half-width 1- or 2-unit 1U rack mount 220x43.2x400mm	480 Gbps	-	-	12 ports 100M; 1G; 2.5G; 5G; 10G	12 ports 1G; 10G	-	-	1 x Fixed 240W (C14) On/Off switch	-			Storage: 2 x USB-A (Back)	XSM4324
M4350-24X4V	Full width 1U rack mount 440x43.2x400mm	680 Gbps	-	-	24 ports PoE+ 100M; 1G; 2.5G; 5G; 10G 576W (base), up to 720W	-	4 ports 1G; 10G; 25G (Ethernet Mode*) (Stacking: 25G**)	-	1 x Fixed 880W (C14) On/Off switch	1 slot				XSM4328CV
M4350-24F4V	Full width 1U rack mount 440x43.2x400mm	680 Gbps	-	-	-	24 ports 1G; 10G	4 ports 1G; 10G; 25G (Ethernet Mode*) (Stacking: 25G**)	-	1 x Fixed 240W (C14) On/Off switch	1 slot				XSM4328FV

* ETHERNET Mode: Each 4 x 25G block is connected to a 100G SERDES. As such, each 4-port block can only work at the same speed: 4x1G, or 4x10G, or 4x25G. Since 25G takes precedence, when one 25G module is inserted, other ports with 1G or 10G modules get down in the same 4-port block.

** STACKING Mode: Stacking link only works on the highest speed supported by a Stack port. A 25G port, when configured in Stack mode, only operates at 25G. It cannot operate at 10G. Similarly, a 100G port, when configured in Stack mode, only operates at 100G.

*** Ultra90 PoE++ 802.3bt is compatible with 802.3af PoE (15.4W), 802.3at PoE+ (30W) and 802.3bt (60W, 75W and 90W).

Hardware-at-a-Glance

Model Name	Form-Factor	Switching Fabric	FRONT						REAR			MANAGEMENT	Model Number
			1000BASE-T RJ45 ports	2.5GBASE-T RJ45 ports	10GBASE-T RJ45 ports	10GBASE-X SFP+ ports	25GBASE-X SFP28 ports	100GBASE-X QSFP28 ports	Internal PSU	Modular PSU Bays	Fans	Out-of-band Console	
M4350-36X4V	Full width 1U rack mount 440x43.2x400mm	920 Gbps	-	-	36 ports PoE+**** 100M; 1G; 2.5G; 5G; 10G 280W (base), up to 1,760W	-	4 ports 1G; 10G; 25G (Ethernet Mode*) (Stacking: 25G**)	-	1 x Fixed 750W (C14) On/Off switch	1 slot	Fixed Front-to-back	Ethernet: Out-of-band 1G port (Back)	XSM4340CV
M4350-24X8F8V	Full width 1U rack mount 440x43.2x400mm	1.04 Tbps	-	-	24 ports PoE+**** 100M; 1G; 2.5G; 5G; 10G 290W (base), up to 1,770W	8 ports 1G; 10G	8 ports 1G; 10G; 25G (Ethernet Mode*) (Stacking: 25G**)	-	1 x Fixed 750W (C14) On/Off switch	1 slot			XSM4340V
M4350-32F8V	Full width 1U rack mount 440x43.2x400mm	1.04 Tbps	-	-	-	32 ports 1G; 10G	8 ports 1G; 10G; 25G (Ethernet Mode*) (Stacking: 25G**)	1 x Fixed 420W (C14) On/Off switch	1 slot	XSM4340FV			
M4350-16V4C	Full width 1U rack mount 440x43.2x400mm	1.6 Tbps	-	-	-	-	16 ports 1G; 10G; 25G (Ethernet Mode*) (Stacking: 25G**)	4 ports 40G; 100G (Stacking: 100G**)	1 x Fixed 420W (C14) On/Off switch	1 slot		Storage: 2 x USB-A (Back)	VSM4320C
M4350-40X4C	Full width 1U rack mount 440x43.2x400mm	1.6 Tbps	-	-	40 ports PoE+**** 100M; 1G; 2.5G; 5G; 10G 196W (base), up to 1,676W	-	-	4 ports 40G; 100G (Stacking: 100G**)	1 x Fixed 750W (C14) On/Off switch	1 slot		XSM4344C	

* ETHERNET Mode: Each 4 x 25G block is connected to a 100G SERDES. As such, each 4-port block can only work at the same speed: 4x1G, or 4x10G, or 4x25G. Since 25G takes precedence, when one 25G module is inserted, other ports with 1G or 10G modules get down in the same 4-port block.

** STACKING Mode: Stacking link only works on the highest speed supported by a Stack port. A 25G port, when configured in Stack mode, only operates at 25G. It cannot operate at 10G. Similarly, a 100G port, when configured in Stack mode, only operates at 100G.

*** Ultra90 PoE++ 802.3bt is compatible with 802.3af PoE (15.4W), 802.3at PoE+ (30W) and 802.3bt (60W, 75W and 90W).



RPS+EPS Wattages*-at-a-Glance

Model Name	Modular PSUs					Model Name	Modular PSUs						
	Internal PSU	PSU Slot 1	PSU Slot 2	Switch Operational Without PoE?	Available PoE Budget		Model Number	Internal PSU	PSU Slot 1	PSU Slot 2	Switch Operational Without PoE?	Available PoE Budget	Model Number
M4350-24G4XF	880W - Connected	Disconnected	-	Yes	648W	GSM4328	M4350-48G4XF	550W - Connected	Disconnected	Disconnected	Yes	236W	GSM4352
	880W - Connected	APS350W	-	Yes	720W			550W - Connected	APS350W	Disconnected	Yes	436W	
	Disconnected	APS350W	-	Yes	218W			Disconnected	APS350W	Disconnected	Yes	186W	
	880W - Connected	APS600Wv2	-	Yes	720W			550W - Connected	APS600Wv2	Disconnected	Yes	636W	
	Disconnected	APS600Wv2	-	Yes	468W			Disconnected	APS600Wv2	Disconnected	Yes	436W	
	880W - Connected	APS920W	-	Yes	720W			550W - Connected	APS920W	Disconnected	Yes	892W	
	Disconnected	APS920W	-	Yes	720W			Disconnected	APS920W	Disconnected	Yes	756W	
	880W - Connected	APS2000W 110VAC	-	Yes	720W			550W - Connected	APS2000W 110VAC	Disconnected	Yes	956W	
	Disconnected	APS2000W 110VAC	-	Yes	720W			Disconnected	APS2000W 110VAC	Disconnected	Yes	836W	
	880W - Connected	APS2000W 220VAC	-	Yes	720W			550W - Connected	APS2000W 220VAC	Disconnected	Yes	1,440W	
Disconnected	APS2000W 220VAC	-	Yes	720W	Disconnected	APS2000W 220VAC	Disconnected	Yes	1,440W				
M4350-48G4XF	550W - Connected	Disconnected	Disconnected	Yes	236W	GSM4352	M4350-44M4X4V	550W - Connected	Disconnected	Disconnected	Yes	194W	MSM4352
	550W - Connected	APS350W	APS350W	Yes	716W			550W - Connected	APS350W	Disconnected	Yes	394W	
	Disconnected	APS350W	APS350W	Yes	396W			Disconnected	APS350W	Disconnected	Yes	144W	
	550W - Connected	APS600Wv2	APS600Wv2	Yes	1,116W			550W - Connected	APS600Wv2	Disconnected	Yes	594W	
	Disconnected	APS600Wv2	APS600Wv2	Yes	796W			Disconnected	APS600Wv2	Disconnected	Yes	394W	
	550W - Connected	APS920W	APS920W	Yes	1,440W			550W - Connected	APS920W	Disconnected	Yes	850W	
	Disconnected	APS920W	APS920W	Yes	1,308W			Disconnected	APS920W	Disconnected	Yes	714W	
	550W - Connected	APS2000W 110VAC	APS2000W 110VAC	Yes	1,440W			550W - Connected	APS2000W 110VAC	Disconnected	Yes	914W	
	Disconnected	APS2000W 110VAC	APS2000W 110VAC	Yes	1,436W			Disconnected	APS2000W 110VAC	Disconnected	Yes	794W	
	550W - Connected	APS2000W 220VAC	APS2000W 220VAC	Yes	1,440W			550W - Connected	APS2000W 220VAC	Disconnected	Yes	1,786W	
Disconnected	APS2000W 220VAC	APS2000W 220VAC	Yes	1,440W	Disconnected	APS2000W 220VAC	Disconnected	Yes	1,694W				
M4350-44M4X4V	550W - Connected	Disconnected	Disconnected	Yes	194W	MSM4352	M4350-24X4V	880W - Connected	Disconnected	-	Yes	576W	XSM4328CV
	550W - Connected	APS350W	APS350W	Yes	674W			880W - Connected	APS350W	-	Yes	700W	
	Disconnected	APS350W	APS350W	Yes	354W			Disconnected	APS350W	-	Yes	146W	
	550W - Connected	APS600Wv2	APS600Wv2	Yes	1,074W			880W - Connected	APS600Wv2	-	Yes	720W	
	Disconnected	APS600Wv2	APS600Wv2	Yes	754W			Disconnected	APS600Wv2	-	Yes	396W	
	550W - Connected	APS920W	APS920W	Yes	1,586W			880W - Connected	APS920W	-	Yes	720W	
	Disconnected	APS920W	APS920W	Yes	1,266W			Disconnected	APS920W	-	Yes	716W	
	550W - Connected	APS2000W 110VAC	APS2000W 110VAC	Yes	1,714W			880W - Connected	APS2000W 110VAC	-	Yes	720W	
	Disconnected	APS2000W 110VAC	APS2000W 110VAC	Yes	1,394W			Disconnected	APS2000W 110VAC	-	Yes	720W	
	550W - Connected	APS2000W 220VAC	APS2000W 220VAC	Yes	3,314W			880W - Connected	APS2000W 220VAC	-	Yes	720W	
Disconnected	APS2000W 220VAC	APS2000W 220VAC	Yes	2,994W	Disconnected	APS2000W 220VAC	-	Yes	720W				

RPS+EPS Wattages*-at-a-Glance

Model Name	Internal PSU	Modular PSUs		Switch Operational Without PoE?	Available PoE Budget	Model Number	Model Name	Internal PSU	Modular PSUs		Switch Operational Without PoE?	Available PoE Budget	Model Number
		PSU Slot 1	PSU Slot 2						PSU Slot 1	PSU Slot 2			
M4350-24F4V	240W - Connected	Disconnected	-	Yes	-	XSM4328FV	M4350-36X4V	750W - Connected	Disconnected	-	Yes	280W	XSM4340CV
	240W - Connected	APS350W	-	Yes	-			750W - Connected	APS600Wv3	-	Yes	640W	
	Disconnected	APS350W	-	Yes	-			Disconnected	APS600Wv3	-	Yes	280W	
	240W - Connected	APS600Wv2	-	Yes	-			750W - Connected	APS1200Wv2 110VAC	-	Yes	960W	
	Disconnected	APS600Wv2	-	Yes	-			Disconnected	APS1200Wv2 110VAC	-	Yes	680W	
	240W - Connected	APS920W	-	Yes	-			750W - Connected	APS1200Wv2 220VAC	-	Yes	1,120W	
	Disconnected	APS920W	-	Yes	-			Disconnected	APS1200Wv2 220VAC	-	Yes	880W	
	240W - Connected	APS2000W 110VAC	-	Yes	-			750W - Connected	APS2000Wv2 110VAC	-	Yes	960W	
	Disconnected	APS2000W 110VAC	-	Yes	-			Disconnected	APS2000Wv2 110VAC	-	Yes	680W	
	240W - Connected	APS2000W 220VAC	-	Yes	-			750W - Connected	APS2000Wv2 220VAC	-	Yes	1,760W	
Disconnected	APS2000W 220VAC	-	Yes	-	Disconnected	APS2000Wv2 220VAC	-	Yes	1,680W				
M4350-24X8F8V	750W - Connected	Disconnected	-	Yes	290W	XSM4340V	M4350-32F8V	420W - Connected	Disconnected	-	Yes	-	XSM4340FV
	750W - Connected	APS600Wv3	-	Yes	650W			420W - Connected	APS600Wv3	-	Yes	-	
	Disconnected	APS600Wv3	-	Yes	290W			Disconnected	APS600Wv3	-	Yes	-	
	750W - Connected	APS1200Wv2 110VAC	-	Yes	970W			420W - Connected	APS1200Wv2 110VAC	-	Yes	-	
	Disconnected	APS1200Wv2 110VAC	-	Yes	690W			Disconnected	APS1200Wv2 110VAC	-	Yes	-	
	750W - Connected	APS1200Wv2 220VAC	-	Yes	1,130W			420W - Connected	APS1200Wv2 220VAC	-	Yes	-	
	Disconnected	APS1200Wv2 220VAC	-	Yes	890W			Disconnected	APS1200Wv2 220VAC	-	Yes	-	
	750W - Connected	APS2000Wv2 110VAC	-	Yes	970W			420W - Connected	APS2000Wv2 110VAC	-	Yes	-	
	Disconnected	APS2000Wv2 110VAC	-	Yes	690W			Disconnected	APS2000Wv2 110VAC	-	Yes	-	
	750W - Connected	APS2000Wv2 220VAC	-	Yes	1,770W			420W - Connected	APS2000Wv2 220VAC	-	Yes	-	
Disconnected	APS2000Wv2 220VAC	-	Yes	1,690W	Disconnected	APS2000Wv2 220VAC	-	Yes	-				
M4350-16V4C	420W - Connected	Disconnected	-	Yes	-	VSM4320C	M4350-40X4C	750W - Connected	Disconnected	-	Yes	196W	XSM4344C
	420W - Connected	APS600Wv3	-	Yes	-			750W - Connected	APS600Wv3	-	Yes	556W	
	Disconnected	APS600Wv3	-	Yes	-			Disconnected	APS600Wv3	-	Yes	196W	
	420W - Connected	APS1200Wv2 110VAC	-	Yes	-			750W - Connected	APS1200Wv2 110VAC	-	Yes	876W	
	Disconnected	APS1200Wv2 110VAC	-	Yes	-			Disconnected	APS1200Wv2 110VAC	-	Yes	596W	
	420W - Connected	APS1200Wv2 220VAC	-	Yes	-			750W - Connected	APS1200Wv2 220VAC	-	Yes	1,036W	
	Disconnected	APS1200Wv2 220VAC	-	Yes	-			Disconnected	APS1200Wv2 220VAC	-	Yes	796W	
	420W - Connected	APS2000Wv2 110VAC	-	Yes	-			750W - Connected	APS2000Wv2 110VAC	-	Yes	876W	
	Disconnected	APS2000Wv2 110VAC	-	Yes	-			Disconnected	APS2000Wv2 110VAC	-	Yes	596W	
	420W - Connected	APS2000Wv2 220VAC	-	Yes	-			750W - Connected	APS2000Wv2 220VAC	-	Yes	1,676W	
Disconnected	APS2000Wv2 220VAC	-	Yes	-	Disconnected	APS2000Wv2 220VAC	-	Yes	1,596W				

* M4350 full width switches offer RPS (redundant power supply) and EPS (extended power supply) modes at the same time, automatically. This table explains the total PoE budget (EPS), and the protected PoE budget (RPS) for each combination of PSU.

Acoustic-at-a-Glance

Model Name	QUIET MODE Setting at ambient* (Default mode)					COOL MODE Setting at ambient*			
	PoE Power Load	Fan Duty	Ambient	Case Temp (Top)	Acoustic	Fan Duty	Case Temp (Top)	Acoustic	Model Number
M4350-24G4XF	720W	28	25°C	33.1°C	33dBA	60	31.9°C	52dBA	GSM4328
	720W	60	45°C	48.2°C	52dBA				
M4350-48G4XF	1,440W	28	25°C	33.4°C	33dBA	60	31.3°C	52dBA	GSM4352
	1,440W	60	45°C	48.5°C	52dBA				
M4350-44M4X4V	3,314W	28	25°C	43.3°C	34dBA	60	38.3°C	52dBA	MSM4352
	3,314W	60	45°C	50.1°C	52dBA				
M4350-8X8F	N/A	27	25°C	34.4°C	34.43dBA	70	30.3°C	56.3dBA	XSM4316
	N/A	70	50°C	51.7°C	56.3dBA				
M4350-12X12F	N/A	27	25°C	31.9°C	34.34dBA	100	29.5°C	64dBA	XSM4324
	N/A	100	50°C	51.5°C	64dBA				
M4350-24X4V	720W	30	25°C	32.3°C	34.7dBA	70	29.6°C	57.2dBA	XSM4328CV
	720W	70	45°C	46.6°C	57.2dBA				
M4350-24F4V	N/A	30	25°C	34.2°C	34.2dBA	85	30.3°C	61.8dBA	XSM4328FV
	N/A	85	50°C	52.4°C	61.8dBA				
M4350-36X4V	1760W	25	25°C	39°C	32.1dBA	60	30.4°C	54dBA	XSM4340CV
	1760W	60	45°C	49.2°C	54dBA				
M4350-24X8F8V	1770W	25	25°C	39.9°C	32.6dBA	60	31°C	53.3dBA	XSM4340V
	1770W	60	45°C	48.5°C	53.3dBA				
M4350-32F8V	N/A	25	25°C	35°C	32.7dBA	80	28.9°C	63dBA	XSM4340FV
	N/A	80	50°C	52.1°C	63dBA				
M4350-16V4C	N/A	28	25°C	38.2°C	36.4dBA	60	30.8°C	55dBA	VSM4320C
	N/A	60	50°C	56°C	55dBA				
M4350-40X4C	1676W	25	25°C	39.9°C	34.1dBA	60	33.9°C	54.3dBA	XSM4344C
	1676W	60	45°C	49.6°C	54.3dBA				

* dBA values are SPL (Sound Pressure Level) values, testing following the ISO-7779 standard. Bystander Mode. Chamber Temp 25°C during testing unless noted otherwise. Full, 100%, Data and PoE loaded. Worst case.

For QUIET MODE, Min conditions are: Lowest fan duty when ambient temperature is 25°C, all ports used, max traffic, max PoE budget (additional PSUs). Worst case.

For QUIET MODE, Max conditions are: Highest fan duty when ambient temperature is 45°C (PoE models) or 50°C (non-PoE models), all ports used, max traffic, max PoE budget (additional PSUs) (if applicable). Worst case.

Software-at-a-Glance

LAYER 3 PACKAGE*													
Model Name	Management	AV Dedicated UI	IPv4 / IPv6 ACL and QoS, DiffServ	IPv4 / IPv6 Multicast Filtering	SMTPE ST 2110	IPv4 / IPv6 Policing and Convergence	Spanning Tree Green Ethernet	VLANs	Trunking Port Channel	IPv4 / IPv6 Authentication Security	IPv4 / IPv6 Static Routing	IPv4 / IPv6 Dynamic Routing	Model Number
M4350 series	Out-of-band	AV Web-based GUI	Ingress/egress	NETGEAR IGMP™ Plus for automated IGMP between switches	Select models only	Auto-VoIP	STP, MTP, RSTP	Static, Dynamic, Voice, MAC	Auto-Trunk and Auto-LAG between M4250, M4300, and M4350 Switches	Successive Tiering (DOT1X; MAB; Captive Portal)	Port, Subnet, VLAN routing	IPv4: RIP, VRRP	All models
	IT Web GUI (main)	Designed for AV installers				LLDP-MED			Static LAG, or Dynamic LACP				
	HTTPs CLI; Telnet; SSH	AV-related controls	1 Kbps shaping Time-based	IGMPv3 MLDv2 Snooping, Proxy ASM & SSM	IEEE 1588 PTPv2 1-Step End-to-End Transparent Clock (TC)	BPDU/STRG Root Guard	GVRP/GMRP	(LACP automatically reverts to and from Static LAG)	DHCP Snooping Dynamic ARP Inspection IP Source Guard	DHCP Relay	Stateful DHCPv6 Server		
	Stacking** NSF with Hitless Failover	Audio over IP profiles	Single Rate Policing	IGMPv1,v2 Querier (compatible v3)	AVB: 802.1AS, 802.1Qav, 802.1Qat MSRP, 802.1ak MMRP, 802.1ak MVRP	EEE 802.3az (EEE is disabled by default)	Double VLAN mode	Private VLANs	Seven (7) L2/L3/L4 hashing algorithm				
	SNMP, MIBs RSPAN	Video over IP profiles		Control Packet Flooding									
	Radius Users, TACACS	Mixed Audio and Video profiles			Boundary Clock mode (BC)								
					Grandmaster Clock mode (GM)								
M4350-16V4C M4350-40X4C		ST 2110 profiles			PTP profiles for: SMPTE 2059-2 (video/audio), AES67 (Audio), AES-R16-2016 (Interoperability)								VSM4320C XSM4344C
					Single-step PTP to AV endpoints								
					Single-step/two-step to the GrandMaste								

* All software features are available, license-free.

** Stacking, AVB, and PTP TC are mutually exclusive features. A stack cannot run AVB, nor PTP TC (or BC/GM).



Performance-at-a-Glance

TABLE SIZE													
Model Name	MAC ARP/NDP	Routing / Switching Capacity	Throughput 64-byte	Application Route Scaling	Packet Buffer	Latency 64-byte	CPU	IP Multicast Routing Entries	Jumbo Frames	Multicast IGMP Group Membership	VLANs	DHCP	Model Number
M4350-24G4XF	16K MAC 4K ARP/ 512 NDP	128 Gbps Line-Rate	95.23 Mpps	Static: 256v4/64v6 RIP: 512 OSPF: 1,024	16Mb	<2.42µs 1G <0.92µs 10G fiber	Quad-Core Cortex-A57 ARMv8 1.8Ghz 64-bit 2GB RAM DDR4	512 IPv4 256 IPv6	Up to 12K	2K IPv4 2K IPv6	4K VLANs	DHCP Server: 2K leases IPv4: 256 pools IPv6: 16 pools	GSM4328
M4350-48G4XF	16K MAC 4K ARP/ 512 NDP	176 Gbps Line-Rate	130.94 Mpps		32Mb	<2.20µs 1G <0.70µs 10G fiber							GSM4352
M4350-44M4X4V	16K MAC 4K ARP/ 512 NDP	500 Gbps Line-Rate	372 Mpps		32Mb	<5.61µs 2.5G <2.27µs 10G copper <0.75µs 25G							MSM4352
M4350-8X8F	16K MAC 4K ARP/ 512 NDP	320 Gbps Line-Rate	238.08 Mpps		32Mb	<2.28µs 1G <2.39µs 10G copper <0.83µs 10G fiber							XSM4316
M4350-12X12F	16K MAC 4K ARP/ 512 NDP	480 Gbps Line-Rate	357.12 Mpps		32Mb	<2.14µs 1G <2.29µs 10G copper <0.72µs 10G fiber							XSM4324
M4350-24X4V	16K MAC 4K ARP/ 512 NDP	680 Gbps Line-Rate	505.92 Mpps		32Mb	<2.43µs 1G <2.20µs 10G copper <0.97µs 25G							XSM4328CV
M4350-24F4V	16K MAC 4K ARP/ 512 NDP	680 Gbps Line-Rate	505.92 Mpps		32Mb	<1.06µs 1G <0.63µs 10G fiber <0.67µs 25G							XSM4328FV
M4350-36X4V	16K MAC 4K ARP/ 512 NDP	920 Gbps Line-Rate	684.48 Mpps		64Mb	<2.54µs 1G <2.75µs 10G copper <1.08µs 25G							XSM4340CV
M4350-24X8F8V	16K MAC 4K ARP/ 512 NDP	1.04 Tbps Line-Rate	773.76 Mpps		64Mb	<2.7µs 10G copper <1.27µs 10G fiber <1.09µs 25G							XSM4340V
M4350-32F8V	16K MAC 4K ARP/ 512 NDP	1.04 Tbps Line-Rate	773.76 Mpps		64Mb	<1.27µs 10G fiber <1.08µs 25G							XSM4340FV
M4350-16V4C	16K MAC 4K ARP/ 512 NDP	1.6 Tbps Line-Rate	1190.4 Mpps	256Mb	<2.71µs 10G fiber <1.08µs 25G <1.13µs 100G	VSM4320C							
M4350-40X4C	16K MAC 4K ARP/ 512 NDP	1.6 Tbps Line-Rate	1190.4 Mpps	256Mb	<2.71µs 10G copper <1.08µs 25G fiber <1.04µs 100G	XSM4344C							

Components

M4350-24G4XF

Fully Managed Switch

Ordering information

- Americas, Europe: GSM4328-100NES (NA, UK, EU)
- Asia Pacific: GSM4328-100AJS (JP, AU)
- China: GSM4328-100PRS
- Warranty: Lifetime ProSAFE Hardware Warranty



- 24 Gigabit PoE+ ports with 4 10GBASE-X SFP+ uplinks.
- 880W internal power supply providing 648W of PoE budget.
- 1 slot for modular power supply (1+1 redundancy and/or EPS share).
- Any APS350W, APS600Wv2, APS920W, or APS2000W can be used.
- The PoE budget can reach 720W, when the redundant PoE budget remains 648W.
- Virtual Chassis stacking provides non-stop forwarding (NSF) and hitless failover.
- Layer 3 feature set includes static, policy-based, and dynamic routing.
- NETGEAR IGMP Plus™, AV User Interface, and Engage Controller speed up AV installations.
- NETGEAR ProSAFE® Limited Lifetime Hardware Warranty.
- Lifetime Next Business Day Hardware Replacement.
- Dimensions: 440*400*43.2 mm
- Weight: 6.41Kg (14.13 lb)



Components

M4350-48G4XF

Fully Managed Switch

Ordering information

- Americas, Europe: GSM4352-100NES (NA, UK, EU)
- Asia Pacific: GSM4352-100AJS (JP, AU)
- China: GSM4352-100PRS
- Warranty: Lifetime ProSAFE Hardware Warranty



- 48 Gigabit PoE+ ports with 4 10GBASE-X SFP+ uplinks.
- 550W internal power supply providing 236W of PoE budget.
- 2 slots for modular power supplies (1+1 redundancy and/or EPS share).
- Any APS350W, APS600Wv2, APS920W, or APS2000W can be used.
- The PoE budget can reach 1,440W, the redundant PoE budget can also reach 1,440W.
- Virtual Chassis stacking provides non-stop forwarding (NSF) and hitless failover.
- Layer 3 feature set includes static, policy-based, and dynamic routing.
- NETGEAR IGMP Plus™, AV User Interface, and Engage Controller speed up AV installations.
- NETGEAR ProSAFE® Limited Lifetime Hardware Warranty.
- Lifetime Next Business Day Hardware Replacement.
- Dimensions: 440x400x43.2 mm
- Weight: 7.19Kg (15.85 lb)



Components

M4350-44M4X4V Fully Managed Switch

Ordering information

- Americas, Europe: MSM4352-100NES (NA, UK, EU)
- Americas, TAA Compliant: MSM4352-TAANES (NA, UK, EU)
- Asia Pacific: MSM4352-100AJS (JP, AU)
- China: MSM4352-100PRS
- Warranty: Lifetime ProSAFE Hardware Warranty



- 44 2.5G and 4 10G/Multi-gig PoE++ ports with 4 25GBASE-X SFP28 uplinks.
- 550W internal power supply providing 194W of PoE budget.
- 2 slots for modular power supplies (1+1 redundancy and/or EPS share).
- Any APS350W, APS600Wv2, APS920W, or APS2000W can be used.
- The PoE budget can reach 3,314W, the redundant PoE budget can reach 1,794W.
- Virtual Chassis stacking provides non-stop forwarding (NSF) and hitless failover.
- Layer 3 feature set includes static, policy-based, and dynamic routing.
- NETGEAR IGMP Plus™, AV User Interface, and Engage Controller speed up AV installations.
- NETGEAR ProSAFE® Limited Lifetime Hardware Warranty.
- Lifetime Next Business Day Hardware Replacement.
- Dimensions: 440x400x43.2 mm
- Weight: 7.34Kg (16.18 lb)

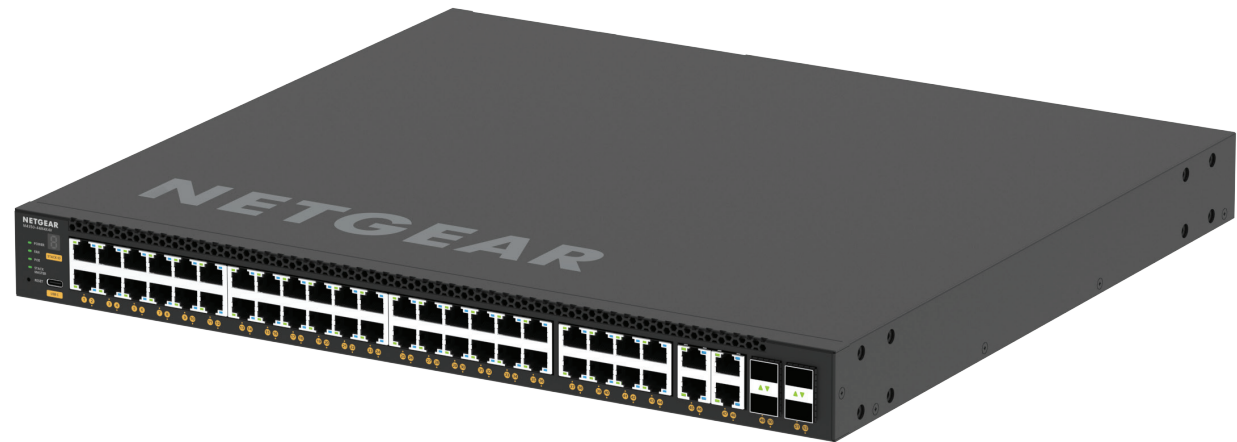

Components

M4350-8X8F

Fully Managed Switch

Ordering information

- Americas, Europe: XSM4316-100NES (NA, UK, EU)
- Asia Pacific: XSM4316-100AJS (JP, AU)
- China: XSM4316-100PRS
- Warranty: Lifetime ProSAFE Hardware Warranty

- 8 10G/Multi-Gig ports, and 8 10GBASE-X SFP+ ports.
- 240W internal power supply.
- Half-width form factor enables one or two switches in a single rack space for redundant top-of-rack.
- Virtual Chassis stacking provides non-stop forwarding (NSF) and hitless failover.
- Layer 3 feature set includes static, policy-based, and dynamic routing.
- NETGEAR IGMP Plus™, AV User Interface, and Engage Controller speed up AV installations.
- NETGEAR ProSAFE® Limited Lifetime Hardware Warranty.
- Lifetime Next Business Day Hardware Replacement.
- Dimensions: 220x400x43.2 mm
- Weight: 4.05Kg (8.93 lb)



Components

M4350-12X12F

Fully Managed Switch

Ordering information

- Americas, Europe: XSM4324-100NES (NA, UK, EU)
- Asia Pacific: XSM4324-100AJS (JP, AU)
- China: XSM4324-100PRS
- Warranty: Lifetime ProSAFE Hardware Warranty

- 12 10G/Multi-Gig ports, and 12 10GBASE-X SFP+ ports.
- 240W internal power supply.
- Half-width form factor enables one or two switches in a single rack space for redundant top-of-rack.
- Virtual Chassis stacking provides non-stop forwarding (NSF) and hitless failover.
- Layer 3 feature set includes static, policy-based, and dynamic routing.
- NETGEAR IGMP Plus™, AV User Interface, and Engage Controller speed up AV installations.
- NETGEAR ProSAFE® Limited Lifetime Hardware Warranty.
- Lifetime Next Business Day Hardware Replacement.
- Dimensions: 220x400x43.2 mm
- Weight: 4.3Kg (9.48 lb)

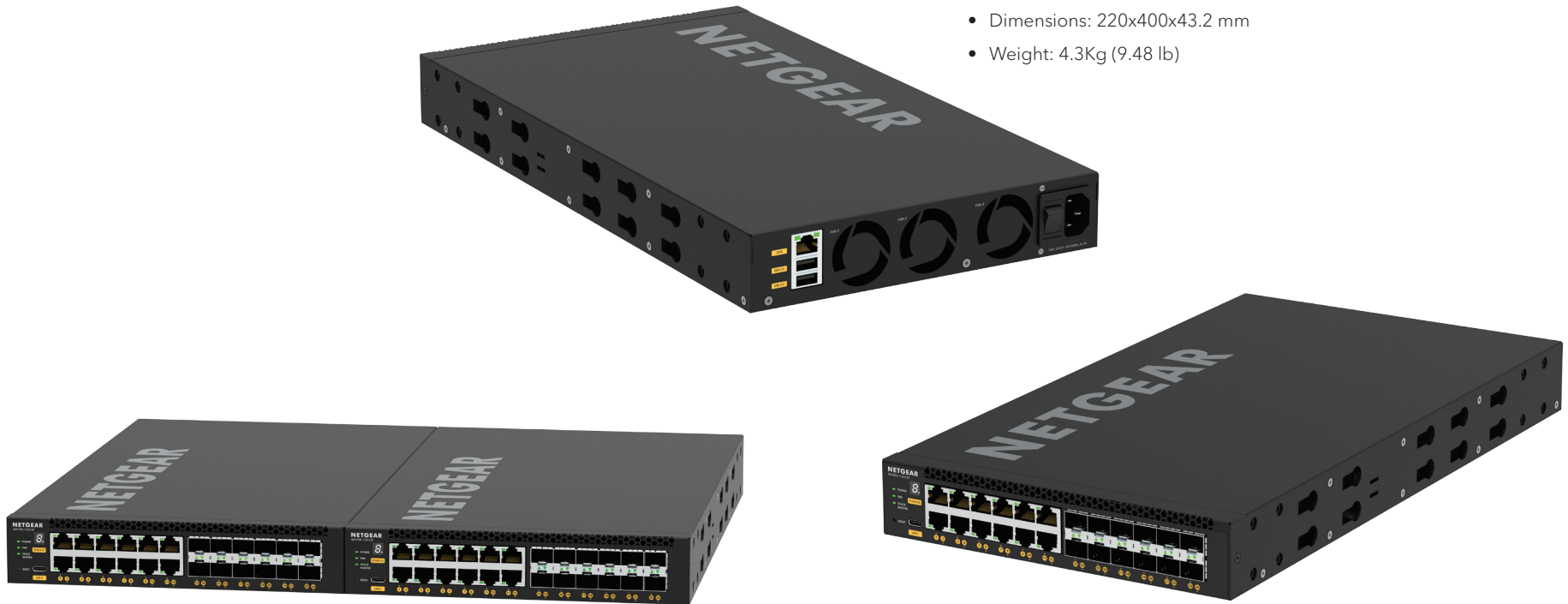

Components

M4350-24X4V

Fully Managed Switch

Ordering information

- Americas, Europe: XSM4328CV-100NES (NA, UK, EU)
- Americas, TAA Compliant: XSM4328CV-TAANES (NA, UK, EU)
- Asia Pacific: XSM4328CV-100AJS (JP, AU)
- China: XSM4328CV-100PRS
- Warranty: Lifetime ProSAFE Hardware Warranty



- 24 10G/Multi-Gig PoE+ ports with 4 25GBASE-X SFP28 uplinks.
- 880W internal power supply providing 576W of PoE budget.
- 1 slot for modular power supply (1+1 redundancy and/or EPS share).
- Any APS350W, APS600Wv2, APS920W, or APS2000W can be used.
- The PoE budget can reach 720W, when the redundant PoE budget remains 576W.
- Virtual Chassis stacking provides non-stop forwarding (NSF) and hitless failover.
- Layer 3 feature set includes static, policy-based, and dynamic routing.
- NETGEAR IGMP Plus™, AV User Interface, and Engage Controller speed up AV installations.
- NETGEAR ProSAFE® Limited Lifetime Hardware Warranty.
- Lifetime Next Business Day Hardware Replacement.
- Dimensions: 440x400x43.2 mm
- Weight: 6.58Kg (14.51 lb)



Components

M4350-24F4V

Fully Managed Switch

Ordering information

- Americas, Europe: XSM4328FV-100NES (NA, UK, EU)
- Asia Pacific: XSM4328FV-100AJS (JP, AU)
- China: XSM4328FV-100PRS
- Warranty: Lifetime ProSAFE Hardware Warranty

- 24 10GBASE-X SFP+ ports with 4 25GBASE-X SFP28 uplinks.
- 240W internal power supply
- 1 slot for modular power supply (1+1 redundancy).
- Any APS350W, APS600Wv2, APS920W, or APS2000W can be used.
- Virtual Chassis stacking provides non-stop forwarding (NSF) and hitless failover.
- Layer 3 feature set includes static, policy-based, and dynamic routing.
- NETGEAR IGMP Plus™, AV User Interface, and Engage Controller speed up AV installations.
- NETGEAR ProSAFE® Limited Lifetime Hardware Warranty.
- Lifetime Next Business Day Hardware Replacement.
- Dimensions: 440x400x43.2 mm
- Weight: 6.25Kg (13.78 lb)



Components

M4350-36X4V

Fully Managed Switch

Ordering information

- Americas, Europe: XSM4340CV-100NES (NA, UK, EU)
- Asia Pacific: XSM4340CV-100AJS (JP, AU)
- China: XSM4340CV-100PRS
- Warranty: Lifetime ProSAFE Hardware Warranty



- 36 10G/Multi-Gig PoE++ ports with 4 25GBASE-X SFP28 uplinks.
- 750W internal power supply providing 280W of PoE budget.
- 1 slot for modular power supply (1+1 redundancy and/or EPS share).
- Any APS600Wv3, APS1200Wv2, or APS2000Wv2 can be used.
- The PoE budget can reach 1,760W, when the redundant PoE budget remains 280W.
- Virtual Chassis stacking provides non-stop forwarding (NSF) and hitless failover.
- Layer 3 feature set includes static, policy-based, and dynamic routing.
- NETGEAR IGMP Plus™, AV User Interface, and Engage Controller speed up AV installations.
- NETGEAR ProSAFE® Limited Lifetime Hardware Warranty.
- Lifetime Next Business Day Hardware Replacement.
- Dimensions: 440x400x43.2 mm
- Weight: 7.33Kg (16.16 lb)



Components

M4350-24X8F8V

Fully Managed Switch

Ordering information

- Americas, Europe: XSM4340V-100NES (NA, UK, EU)
- Americas, TAA Compliant: XSM4340V-TAANES (NA, UK, EU)
- Asia Pacific: XSM4340V-100AJS (JP, AU)
- China: XSM4340V-100PRS
- Warranty: Lifetime ProSAFE Hardware Warranty



- 24 10G/Multi-Gig PoE++ ports, 8 10GBASE-X SFP+ and 8 25GBASE-X SFP28 ports.
- 750W internal power supply providing 290W of PoE budget.
- 1 slot for modular power supply (1+1 redundancy and/or EPS share).
- Any APS600Wv3, APS1200Wv2, or APS2000Wv2 can be used.
- The PoE budget can reach 1,770W, when the redundant PoE budget remains 290W.
- Virtual Chassis stacking provides non-stop forwarding (NSF) and hitless failover.
- Layer 3 feature set includes static, policy-based, and dynamic routing.
- NETGEAR IGMP Plus™, AV User Interface, and Engage Controller speed up AV installations.
- NETGEAR ProSAFE® Limited Lifetime Hardware Warranty.
- Lifetime Next Business Day Hardware Replacement.
- Dimensions: 440x400x43.2 mm
- Weight: 7.24Kg (15.96 lb)



Components

M4350-32F8V

Fully Managed Switch

Ordering information

- Americas, Europe: XSM4340FV-100NES (NA, UK, EU)
- Americas, TAA Compliant: XSM4340FV-TAANES (NA, UK, EU)
- Asia Pacific: XSM4340FV-100AJS (JP, AU)
- China: XSM4340FV-100PRS
- Warranty: Lifetime ProSAFE Hardware Warranty



- 32 10GBASE-X SFP+ ports with 8 25GBASE-X SFP28 uplinks.
- 420W internal power supply
- 1 slot for modular power supply (1+1 redundancy).
- Any APS600Wv3, APS1200Wv2, or APS2000Wv2 can be used.
- Virtual Chassis stacking provides non-stop forwarding (NSF) and hitless failover.
- Layer 3 feature set includes static, policy-based, and dynamic routing.
- NETGEAR IGMP Plus™, AV User Interface, and Engage Controller speed up AV installations.
- NETGEAR ProSAFE® Limited Lifetime Hardware Warranty.
- Lifetime Next Business Day Hardware Replacement.
- Dimensions: 440x400x43.2 mm
- Weight: 6.95Kg (15.32 lb)



Components

M4350-16V4C

Fully Managed Switch

Ordering information

- Americas, Europe: VSM4320C-100NES (NA, UK, EU)
- Americas, TAA Compliant: VSM4320C-TAANES (NA, UK, EU)
- Asia Pacific: VSM4320C-100AJS (JP, AU)
- China: VSM4320C-100PRS
- Warranty: Lifetime ProSAFE Hardware Warranty



- 16 25GBASE-X SFP28 ports with 4 100GBASE-X QSFP28 uplinks.
- 420W internal power supply
- 1 slot for modular power supply (1+1 redundancy).
- Any APS600Wv3, APS1200Wv2, or APS2000Wv2 can be used.
- Virtual Chassis stacking provides non-stop forwarding (NSF) and hitless failover.
- Layer 3 feature set includes static, policy-based, and dynamic routing.
- NETGEAR IGMP Plus™, AV User Interface, and Engage Controller speed up AV installations.
- NETGEAR ProSAFE® Limited Lifetime Hardware Warranty.
- Lifetime Next Business Day Hardware Replacement.
- Dimensions: 440x400x43.2 mm
- Weight: 7.15Kg (15.77 lb)

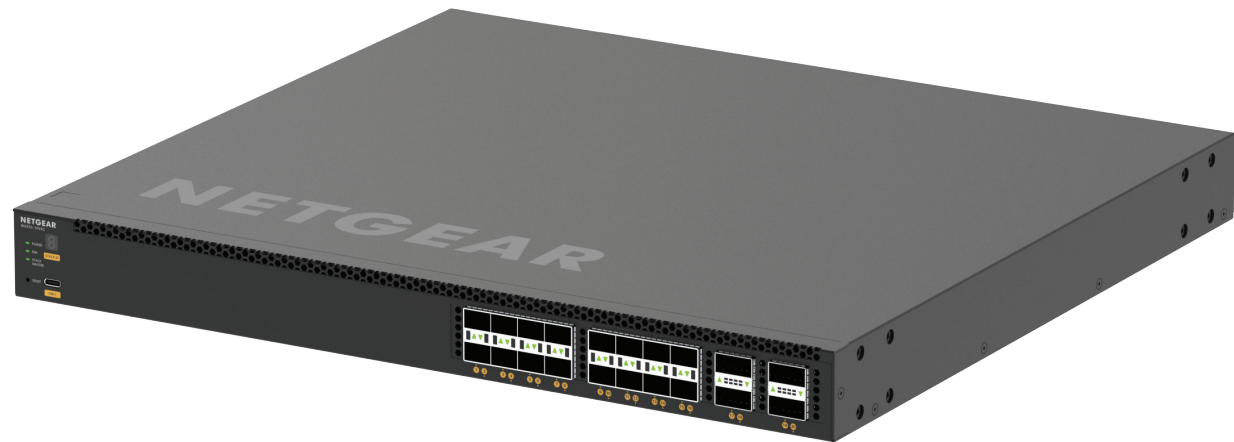

Components

M4350-40X4C

Fully Managed Switch

Ordering information

- Americas, Europe: XSM4344C-100NES (NA, UK, EU)
- Americas, TAA Compliant: XSM4344C-TAANES (NA, UK, EU)
- Asia Pacific: XSM4344C-100AJS (JP, AU)
- China: XSM4344C-100PRS
- Warranty: Lifetime ProSAFE Hardware Warranty



- 40 10G/Multi-Gig PoE++ ports with 4 100GBASE-X QSFP28 uplinks.
- 750W internal power supply providing 196W of PoE budget.
- 1 slot for modular power supply (1+1 redundancy and/or EPS share).
- Any APS600Wv3, APS1200Wv2, or APS2000Wv2 can be used.
- The PoE budget can reach 1,676W, when the redundant PoE budget remains 196W.
- Virtual Chassis stacking provides non-stop forwarding (NSF) and hitless failover.
- Layer 3 feature set includes static, policy-based, and dynamic routing.
- NETGEAR IGMP Plus™, AV User Interface, and Engage Controller speed up AV installations.
- NETGEAR ProSAFE® Limited Lifetime Hardware Warranty.
- Lifetime Next Business Day Hardware Replacement.
- Dimensions: 440x400x43.2 mm
- Weight: 7.76Kg (17.11 lb)



Components

APS350W

Power Supply Unit

Ordering information

- Americas, Europe: APS350W-100NES (NA, UK, EU)
- Asia Pacific: APS350W-100AJS (JP, AU)
- Asia Pacific: APS350W-10000S (no power cord)
- Warranty: 5 years



- PSU for M4350-24G4XF (GSM4328), M4350-48G4XF (GSM4352), M4350-44M4X4V (MSM4352), M4350-24X4V (XSM4328CV), and M4350-24F4V (XSM4328FV).
- C14 connector.
- 110V-240V AC power input.
- Up to 350W output power at 110/220V AC.
- 5-Year Warranty

APS600Wv2

Power Supply Unit

Ordering information

- Americas, Europe: APS600W-200NES (NA, UK, EU)
- Asia Pacific: APS600W-200AJS (JP, AU)
- Asia Pacific: APS600W-20000S (no power cord)
- Warranty: 5 years



- PSU for M4350-24G4XF (GSM4328), M4350-48G4XF (GSM4352), M4350-44M4X4V (MSM4352), M4350-24X4V (XSM4328CV), and M4350-24F4V (XSM4328FV).
- C14 connector.
- 110V-240V AC power input.
- Up to 600W output power at 110/220V AC.
- 5-Year Warranty

Components

APS600Wv3

Power Supply Unit

Ordering information

- Americas, Europe: APS600W-300NES (NA, UK, EU)
- Asia Pacific: APS600W-300AJS (JP, AU)
- Asia Pacific: APS600W-30000S (no power cord)
- Warranty: 5 years



- PSU for M4350-36X4V (XSM4340CV), M4350-24X8F8V (XSM4340V), M4350-32F8V (XSM4340FV), M4350-16V4C (VSM4320C), and M4350-40X4C (XSM4344C).
- C14 connector.
- 110V-240V AC power input.
- Up to 600W output power at 110/220V AC.
- 5-Year Warranty

APS920W

Power Supply Unit

Ordering information

- Americas, Europe: APS920W-100NES (NA, UK, EU)
- Asia Pacific: APS920W-100AJS (JP, AU)
- Asia Pacific: APS920W-10000S (no power cord)
- Warranty: 5 years



- PSU for M4350-24G4XF (GSM4328), M4350-48G4XF (GSM4352), M4350-44M4X4V (MSM4352), M4350-24X4V (XSM4328CV), and M4350-24F4V (XSM4328FV).
- C14 connector.
- 110V-240V AC power input.
- Up to 920W output power at 110/220V AC.
- 5-Year Warranty

Components

APS1200Wv2

Power Supply Unit

Ordering information

- Americas, Europe: APS1200W-200NES (NA, UK, EU)
- Asia Pacific: APS1200W-200AJS (JP, AU)
- Asia Pacific: APS1200W-20000S (no power cord)
- Warranty: 5 years



- PSU for M4350-36X4V (XSM4340CV), M4350-24X8F8V (XSM4340V), M4350-32F8V (XSM4340FV), M4350-16V4C (VSM4320C), and M4350-40X4C (XSM4344C).
- C14 connector.
- 110V-240V AC power input.
- Up to 1,200W output power at 110/220V AC.
- 5-Year Warranty

APS2000W

Power Supply Unit

Ordering information

- Americas, Europe: APS2000W-100NES (NA, UK, EU)
- Asia Pacific: APS2000W-100AJS (JP, AU)
- Asia Pacific: APS2000W-10000S (no power cord)
- Warranty: 5 years



- PSU for M4350-24G4XF (GSM4328), M4350-48G4XF (GSM4352), M4350-44M4X4V (MSM4352), M4350-24X4V (XSM4328CV), and M4350-24F4V (XSM4328FV).
- C14 connector.
- 110V-240V AC power input.
- Up to 1,000W output power at 110V AC.
- Up to 2,000W output power at 220V AC.
- 5-Year Warranty

Components

APS2000Wv2 Power Supply Unit

Ordering information

- Americas, Europe: APS2000W-200NES (NA, UK, EU)
- Asia Pacific: APS2000W-200AJS (JP, AU)
- Asia Pacific: APS2000W-20000S (no power cord)
- Warranty: 5 years





- PSU for M4350-36X4V (XSM4340CV), M4350-24X8F8V (XSM4340V), M4350-32F8V (XSM4340FV), M4350-16V4C (VSM4320C), and M4350-40X4C (XSM4344C).
- C14 connector.
- 110V-240V AC power input.
- Up to 1,000W output power at 110V AC.
- Up to 2,000W output power at 220V AC.
- 5-Year Warranty



Accessories

GBIC SFP and SFP+ Optics for M4350 series

Ordering information <ul style="list-style-type: none"> Worldwide: see table below Warranty: 5 years 	Multimode Fiber (MMF)		Single mode Fiber (SMF)
	OM1 or OM2 62.5/125µm	OM3 or OM4 50/125µm	9/125µm
<p>10 Gigabit SFP+</p>  <ul style="list-style-type: none"> Fits into M4350 SFP+ and SFP28* interfaces 	<p>AXM763</p> <p>10GBase-LRM long reach multimode 802.3aq - LC duplex connector up to 100m (328 ft)</p> <p>AXM763-10000S (1 unit)</p>	<p>AXM763</p> <p>10GBase-LRM long reach multimode 802.3aq - LC duplex connector up to 165m (541 ft)</p> <p>AXM763-10000S (1 unit)</p> <p>AXM761</p> <p>10GBase-SR short reach multimode LC duplex connector up to 300m (984 ft)</p> <p>AXM761-10000S (1 unit) AXM761P10-10000S (pack of 10 units)</p>	<p>AXM762</p> <p>10GBase-LR long reach single mode LC duplex connector up to 10km (6.2 miles)</p> <p>AXM762-10000S (1 unit) AXM762P10-10000S (pack of 10 units)</p> <p>AXM764</p> <p>10GBase-LR LITE single mode LC duplex connector up to 2km (1.2 mile)</p> <p>AXM764-10000S (1 unit)</p>
<p>Gigabit SFP</p>  <ul style="list-style-type: none"> Fits into M4350 SFP+ and SFP28* interfaces 	<p>AGM731F</p> <p>1000Base-SX short range multimode LC duplex connector up to 275m (902 ft)</p> <p>AGM731F (1 unit)</p>	<p>AGM731F</p> <p>1000Base-SX short range multimode LC duplex connector</p> <p>OM3: up to 550m (1,804 ft) OM4: up to 1,000m (3,280 ft)</p> <p>AGM731F (1 unit)</p>	<p>AGM732F</p> <p>1000Base-LX long range single mode LC duplex connector up to 10km (6.2 miles)</p> <p>AGM732F (1 unit)</p>

* ETHERNET Mode: Each 4 x 25G block is connected to a 100G SERDES. As such, each 4-port block can only work at the same speed: 4x1G, or 4x10G, or 4x25G. Since 25G takes precedence, when one 25G module is inserted, other ports with 1G or 10G modules get down in the same 4-port block.

STACKING Mode: Stacking link only works on the highest speed supported by a Stack port. A 25G port, when configured in Stack mode, only operates at 25G. It cannot operate at 10G. Similarly, a 100G port, when configured in Stack mode, only operates at 100G.

<p>AGM734 1000BASE-T RJ45 SFP (Gigabit)</p>	<p>Ordering information</p> <ul style="list-style-type: none"> Worldwide: AGM734-10000S Warranty: 5 years 		<ul style="list-style-type: none"> Fits into M4350 SFP+ and SFP28* interfaces 1 port Gigabit RJ45 Supports only 1000Mbps full-duplex mode Up to 100m (328 ft) with Cat5 RJ45 or better Conveniently adds 1G copper connectivity to M4350 fiber interfaces
<p>AXM765 10GBASE-T RJ45 SFP+ (10 Gigabit)</p>	<p>Ordering information</p> <ul style="list-style-type: none"> Worldwide: AXM765-20000S Warranty: 5 years 		<ul style="list-style-type: none"> Fits into M4350 SFP+ and SFP28* interfaces 1 port 10GBASE-T RJ45 Copper connectivity up to 80m (262 ft) distance CAT6a or better wiring required for 10GBASE-T up to 80 meters Conveniently adds 10G copper connectivity to M4350 fiber interfaces

Accessories

Direct Attach Cables for M4350 series

ORDERING INFORMATION WORLDWIDE: SEE TABLE BELOW WARRANTY: 5 YEARS	SFP+ to SFP+		
	1 meter (3.3 ft)	3 meters (9.8 ft)	5 meters (16.4 ft)
<p>10 Gigabit DAC</p>  <ul style="list-style-type: none"> • Fits into M4350 SFP+ and SFP28* interfaces 	<p>AXC761 10GSFP+ Cu (passive) SFP+ connectors</p> <p>AXC761-10000S (1 unit)</p>	<p>AXC763 10GSFP+ Cu (passive) SFP+ connectors</p> <p>AXC763-10000S (1 unit)</p>	<p>AXC765 10GSFP+ Cu (active) SFP+ connectors</p> <p>AXC765-10000S (1 unit)</p>
	7 meters (23.0 ft)	10 meters (32.8 ft)	15 meters (49.2 ft)
	<p>AXC767 10GSFP+ Cu (active) SFP+ connectors</p> <p>AXC767-10000S (1 unit)</p>	<p>AXC7610 10GSFP+ Cu (active) SFP+ connectors</p> <p>AXC7610-10000S (1 unit)</p>	<p>AXC7615 10GSFP+ (duplex fiber optic) SFP+ connectors</p> <p>AXC7615-10000S (1 unit)</p>
	20 meters (65.6 ft)		
	<p>AXC7620 10GSFP+ (duplex fiber optic) SFP+ connectors</p> <p>AXC7620-10000S (1 unit)</p>		

* ETHERNET Mode: Each 4 x 25G block is connected to a 100G SERDES. As such, each 4-port block can only work at the same speed: 4x1G, or 4x10G, or 4x25G. Since 25G takes precedence, when one 25G module is inserted, other ports with 1G or 10G modules get down in the same 4-port block.

STACKING Mode: Stacking link only works on the highest speed supported by a Stack port. A 25G port, when configured in Stack mode, only operates at 25G. It cannot operate at 10G. Similarly, a 100G port, when configured in Stack mode, only operates at 100G.

Ordering Information

NETGEAR M4350-24G4XF Fully Managed Switch (GSM4328) - 24x1G PoE+ and 4xSFP+ (648W base, up to 720W)	
North America; Europe	GSM4328-100NES (NA, UK, EU)
Asia Pacific	GSM4328-100AJS (JP, AU)
Asia Pacific	GSM4328-100PRS (CCC)
NETGEAR M4350-48G4XF Fully Managed Switch (GSM4352) - 48x1G PoE+ and 4xSFP+ (236W base, up to 1,440W)	
North America; Europe	GSM4352-100NES (NA, UK, EU)
Asia Pacific	GSM4352-100AJS (JP, AU)
Asia Pacific	GSM4352-100PRS (CCC)
NETGEAR M4350-44M4X4V Fully Managed Switch (MSM4352) - 44x2.5G, 4x10G/Multi-Gig PoE++ and 4xSFP28 25G (194W base, up to 3,314W)	
North America; Europe	MSM4352-100NES (NA, UK, EU)
North America; TAA Compliant	MSM4352-TAANES (NA, UK, EU)
Asia Pacific	MSM4352-100AJS (JP, AU)
Asia Pacific	MSM4352-100PRS (CCC)
NETGEAR M4350-8X8F Fully Managed Switch (XSM4316) - 8x10G/Multi-Gig and 8xSFP+	
North America; Europe	XSM4316-100NES (NA, UK, EU)
Asia Pacific	XSM4316-100AJS (JP, AU)
Asia Pacific	XSM4316-100PRS (CCC)
NETGEAR M4350-12X12F Fully Managed Switch (XSM4324) - 12x10G/Multi-Gig and 12xSFP+	
North America; Europe	XSM4324-100NES (NA, UK, EU)
Asia Pacific	XSM4324-100AJS (JP, AU)
Asia Pacific	XSM4324-100PRS (CCC)
NETGEAR M4350-24X4V Fully Managed Switch (XSM4328CV) - 24x10G/Multi-Gig PoE+ and 4xSFP28 25G (576W base, up to 720W)	
North America; Europe	XSM4328CV-100NES (NA, UK, EU)
North America; TAA Compliant	XSM4328CV-TAANES (NA, UK, EU)
Asia Pacific	XSM4328CV-100AJS (JP, AU)
Asia Pacific	XSM4328CV-100PRS (CCC)
NETGEAR M4350-24F4V Fully Managed Switch (XSM4328FV) - 24xSFP+ and 4xSFP28 25G	
North America; Europe	XSM4328FV-100NES (NA, UK, EU)
Asia Pacific	XSM4328FV-100AJS (JP, AU)
Asia Pacific	XSM4328FV-100PRS (CCC)



GSM4328



GSM4352



MSM4352



XSM4316



XSM4324







XSM4328CV



XSM4328FV

Ordering Information

NETGEAR M4350-36X4V Fully Managed Switch (XSM4340CV) - 36x10G/Multi-Gig PoE++ and 4xSFP28 25G (280W base, up to 1,760W)		
North America; Europe	XSM4340CV-100NES (NA, UK, EU)	XSM4340CV
Asia Pacific	XSM4340CV-100AJS (JP, AU)	
Asia Pacific	XSM4340CV-100PRS (CCC)	
NETGEAR M4350-24X8F8V Fully Managed Switch (XSM4340V) - 24x10G/Multi-Gig PoE++, 8xSFP+ and 8xSFP28 25G (290W base, up to 1,770W)		
North America; Europe	XSM4340V-100NES (NA, UK, EU)	XSM4340V
North America; TAA Compliant	XSM4340V-TAANES (NA, UK, EU)	
Asia Pacific	XSM4340V-100AJS (JP, AU)	
Asia Pacific	XSM4340V-100PRS (CCC)	
NETGEAR M4350-32F8V Fully Managed Switch (XSM4340FV) - 32xSFP+ and 8xSFP28 25G		
North America; Europe	XSM4340FV-100NES (NA, UK, EU)	XSM4340FV
North America; TAA Compliant	XSM4340FV-TAANES (NA, UK, EU)	
Asia Pacific	XSM4340FV-100AJS (JP, AU)	
Asia Pacific	XSM4340FV-100PRS (CCC)	
NETGEAR M4350-16V4C Fully Managed Switch (VSM4320C) - 16xSFP28 25G and 4xQSFP28 100G		
North America; Europe	VSM4320C-100NES (NA, UK, EU)	VSM4320C
North America; TAA Compliant	VSM4320C-TAANES (NA, UK, EU)	
Asia Pacific	VSM4320C-100AJS (JP, AU)	
Asia Pacific	VSM4320C-100PRS (CCC)	
NETGEAR M4350-40X4C Fully Managed Switch (XSM4344C) - 40x10G/Multi-Gig PoE++ and 4xQSFP28 100G (196W base, up to 1,676W)		
North America; Europe	XSM4344C-100NES (NA, UK, EU)	XSM4344C
North America; TAA Compliant	XSM4344C-TAANES (NA, UK, EU)	
Asia Pacific	XSM4344C-100AJS (JP, AU)	
Asia Pacific	XSM4344C-100PRS (CCC)	
NETGEAR APS350W - 350W Power Supply Unit for M4350-24G4XF (GSM4328); M4350-48G4XF (GSM4352); M4350-44M4X4V (MSM4352); M4350-24X4V (XSM4328CV); M4350-24F4V (XSM4328FV)		M4350-24G4XF (GSM4328) M4350-48G4XF (GSM4352) M4350-44M4X4V (MSM4352) M4350-24X4V (XSM4328CV) M4350-24F4V (XSM4328FV)
North America; Europe	APS350W-100NES (NA, UK, EU)	
Asia Pacific	APS350W-100AJS (JP, AU)	
NETGEAR APS600Wv2 - 600W Power Supply Unit for M4350-24G4XF (GSM4328); M4350-48G4XF (GSM4352); M4350-44M4X4V (MSM4352); M4350-24X4V (XSM4328CV); M4350-24F4V (XSM4328FV)		
North America; Europe	APS600W-200NES (NA, UK, EU)	
Asia Pacific	APS600W-200AJS (JP, AU)	
Asia Pacific	APS600W-20000S (no power cords)	

Ordering Information

NETGEAR APS920W - 920W Power Supply Unit for M4350-24G4XF (GSM4328); M4350-48G4XF (GSM4352); M4350-44M4X4V (MSM4352); M4350-24X4V (XSM4328CV); M4350-24F4V (XSM4328FV)		
North America; Europe	APS920W-100NES (NA, UK, EU)	
Asia Pacific	APS920W-100AJS (JP, AU)	M4350-24G4XF (GSM4328)
Asia Pacific	APS920W-10000S (no power cords)	M4350-48G4XF (GSM4352)
NETGEAR APS2000W - 2000W Power Supply Unit for M4350-24G4XF (GSM4328); M4350-48G4XF (GSM4352); M4350-44M4X4V (MSM4352); M4350-24X4V (XSM4328CV); M4350-24F4V (XSM4328FV)		M4350-44M4X4V (MSM4352)
North America; Europe	APS2000W-100NES (NA, UK, EU)	M4350-24X4V (XSM4328CV)
Asia Pacific	APS2000W-100AJS (JP, AU)	M4350-24F4V (XSM4328FV)
Asia Pacific	APS2000W-10000S (no power cords)	
NETGEAR APS600Wv3 - 600W Power Supply Unit for M4350-36X4V (XSM4340CV); M4350-24X8F8V (XSM4340V); M4350-32F8V (XSM4340FV); M4350-16V4C (VSM4320C); M4350-40X4C (XSM4344C)		
North America; Europe	APS600W-300NES (NA, UK, EU)	
Asia Pacific	APS600W-300AJS (JP, AU)	
Asia Pacific	APS600W-30000S (no power cords)	
NETGEAR APS1200Wv2 - 1200W Power Supply Unit for M4350-36X4V (XSM4340CV); M4350-24X8F8V (XSM4340V); M4350-32F8V (XSM4340FV); M4350-16V4C (VSM4320C); M4350-40X4C (XSM4344C)		M4350-36X4V (XSM4340CV)
North America; Europe	APS1200W-200NES (NA, UK, EU)	M4350-24X8F8V (XSM4340V)
Asia Pacific	APS1200W-200AJS (JP, AU)	M4350-32F8V (XSM4340FV)
Asia Pacific	APS1200W-20000S (no power cords)	M4350-16V4C (VSM4320C)
NETGEAR APS2000Wv2 - 2000W Power Supply Unit for M4350-36X4V (XSM4340CV); M4350-24X8F8V (XSM4340V); M4350-32F8V (XSM4340FV); M4350-16V4C (VSM4320C); M4350-40X4C (XSM4344C)		M4350-40X4C (XSM4344C)
North America; Europe	APS2000W-200NES (NA, UK, EU)	
Asia Pacific	APS2000W-200AJS (JP, AU)	
Asia Pacific	APS2000W-20000S (no power cords)	

** This product comes with a limited warranty that is valid only if purchased from a NETGEAR authorized reseller, and covers unmodified hardware, fans and internal power supplies - not software or external power supplies, and requires product registration at <https://www.netgear.com/business/registration> within 90 days of purchase; see <https://www.netgear.com/about/warranty> for details. Intended for indoor use only.

NETGEAR, the NETGEAR Logo and ProSAFE are trademarks of NETGEAR, Inc. in the United States and/or other countries. Other brand names mentioned herein are for identification purposes only and may be trademarks of their respective holder(s). Information is subject to change without notice. © 2023 NETGEAR, Inc. All rights reserved.

NETGEAR, Inc. 350 E. Plumeria Drive, San Jose, CA 95134-1911 USA, 1-888-NETGEAR (638-4327), E-mail: info@NETGEAR.com, www.NETGEAR.com

Bro-M4350-5Sep23